



TEST REPORT Engineering Recommendation G99 Requirements for the connection of generation equipment in parallel with public distribution networks	
Report Reference No.:	220700014SHA-001
Tested by (name + signature)	Sleif Sui 
Approved by (name + signature)	Robin Xu 
Date of issue	2022-07-05
Contents	55 pages
Testing Laboratory	Intertek Testing Services Shanghai.
Address.....	Building No.86, 1198 Qinzhou Road (North), Shanghai 200233, China.
Applicant's name	Afore New Energy Technology (Shanghai) Co., Ltd.
Address.....	Build No.7, 333 Wanfang Road, Minhang District, Shanghai. China. 201112
Test specification:	
Standard	G99 Issue 1 Amendment 8, 1 September 2021
Test procedure.....	Type approval for Type A
Non-standard test method.....	N/A
Test Report Form/blank test report	
Test Report Form No.:	TTRF_G99_1_6_2020_V1.1
TRF Originator	Intertek
Master TRF	2019-06
This publication may be reproduced in whole or in part for non-commercial purpose as long as Intertek is acknowledged as copyright owner and source of the material. Intertek takes no responsibility and will not assume liability for damages resulting from the reader's interpretation of the reproduced material due to its placement and context.	

This report is for the exclusive use of Intertek's Client and is provided pursuant to the agreement between Intertek and its Client. Intertek's responsibility and liability are limited to the terms and conditions of the agreement. Intertek assumes no liability to any party, other than to the Client in accordance with the agreement, for any loss, expense or damage occasioned by the use of this report. Only the Client is authorized to permit copying or distribution of this report and then only in its entirety. Any use of the Intertek name or one of its marks for the sale or advertisement of the tested material, product or service must first be approved in writing by Intertek. The observations and test results in this report are relevant only to the sample tested. This report by itself does not imply that the material, product, or service is or has ever been under an Intertek certification program.

Test item description:	Grid-connected PV inverter
Trade Mark.....:	Afore
Manufacturer.....:	Same as applicant
Model/Type reference.....:	HNS4000TL, HNS5000TL, HNS6000TL, HNS7000TL, HNS8000TL, HNS9000TL, HNS10000TL
Rating.....:	See below Specifications table

Specifications table				
Model	HNS4000TL	HNS5000TL	HNS6000TL	HNS7000TL
Input:				
Vmax PV (Vdc)	600	600	600	600
Isc PV (absolute Max.) (A)	18 x 2	18 x 2	18 x 2	18+35
Number MPP trackers	2	2	2	2
Number input strings	1/1	1/1	1/1	1/2
Max. PV input current(A)	14 x 2	14 x 2	14 x 2	14+26
MPPT voltage range (Vdc)	70-550	70-550	70-550	70-550
Vdc range @ full power (Vdc)	145-550	180-550	220-550	220-550
Output				
Normal Voltage(V)	L/N/PE, 220/230240/Vac			
Frequency (Hz)	50/60Hz			
Current (normal) (A)	17.4	21.8	26.1	30.5
Current (Max. continuous) (A)	20	24	28.7	33.6
Power rating (W)	4000	5000	6000	7000
Power Rating (VA)	4000	5000	6000	7000
Power factor /rated	1 (-0,8~+0,8 adjustable)			
others				
Protective class	Class I			
Ingress protection (IP)	IP 65			
Temperature (°C)	-25 ~ +60°C (Derating 45°C)			
Inverter Isolation	Non-isolated			
Overvoltage category	OVC III (AC Main), OVC II (PV)			
Firmware version	V06			

Specifications table			
Model	HNS8000TL	HNS9000TL	HNS10000TL
Input:			
Vmax PV (Vdc)	600	600	600
Isc PV (absolute Max.) (A)	18+35	35 x 2	35 x 2
Number MPP trackers	2	2	2
Number input strings	1/2	2/2	2/2
Max. PV input current(A)	14+26	26 x 2	26 x 2
MPPT voltage range (Vdc)	70-550	70-550	70-550
Vdc range @ full power (Vdc)	220-550	220-550	220-550
Output			
Normal Voltage(V)	L/N/PE, 220/230240/Vac		
Frequency (Hz)	50/60Hz		
Current (normal) (A)	34.8	39.2	43.5
Current (Max. continuous) (A)	38.3	45	50
Power rating (W)	8000	9000	10000
Power Rating (VA)	8000	9000	10000
Power factor /rated	1 (-0,8~+0,8 adjustable)		
others			
Protective class	Class I		
Ingress protection (IP)	IP 65		
Temperature (°C)	-25 ~ +60°C (Derating 45°C)		
Inverter Isolation	Non-isolated		
Overvoltage category	OVC III (AC Main), OVC II (PV)		
Firmware version	V06		

Possible test case verdicts:

- test case does not apply to the test object..... : N/A
- test object does meet the requirement : P(Pass)
- test object does not meet the requirement : F(Fail)

Testing..... :

Date of receipt of test item..... : 2022-06-23

Date (s) of performance of tests..... : 2022-06-23 to 2022-07-01

General remarks:

This report only considered the from A2-3 type test, and only considered the 230Vac, 50Hz.

The test results presented in this report are only to the object (single power inverter unit) tested and base on Low Voltage connected on small power station. The information about Generating Plant is not consider and testing.

Installer and relevant persons shall comply with G99, Local code and Grid Code in G99.

This report shall not be reproduced, except in full, without the written approval of the Issuing testing laboratory.

"(see Enclosure #)" refers to additional information appended to the report.

"(see appended table)" refers to a table appended to the report.

Throughout this report a point is used as the decimal separator.

Determination of the test conclusion is based on IEC Guide 115 in consideration of measurement uncertainty.

Determination of the test result includes consideration of measurement uncertainty from the test equipment and methods.

The test results presented in this report relate only to the item tested. The results indicate that the specimen partially complies with standard"ER G99/1". See general product information next for details information.

General product information:

The testing item is a grid-connected type inverter for indoor or outdoor installation.

The Inverter is single-phase type and non-isolated between input and output.

The relays are designed to redundant structure that controlled by separately.

The master controller and slave controller are used together to control relay open or close, if the single fault on one controller, the other controller can be capable to open the relay, so that still providing safety means.

The topology diagram as following:

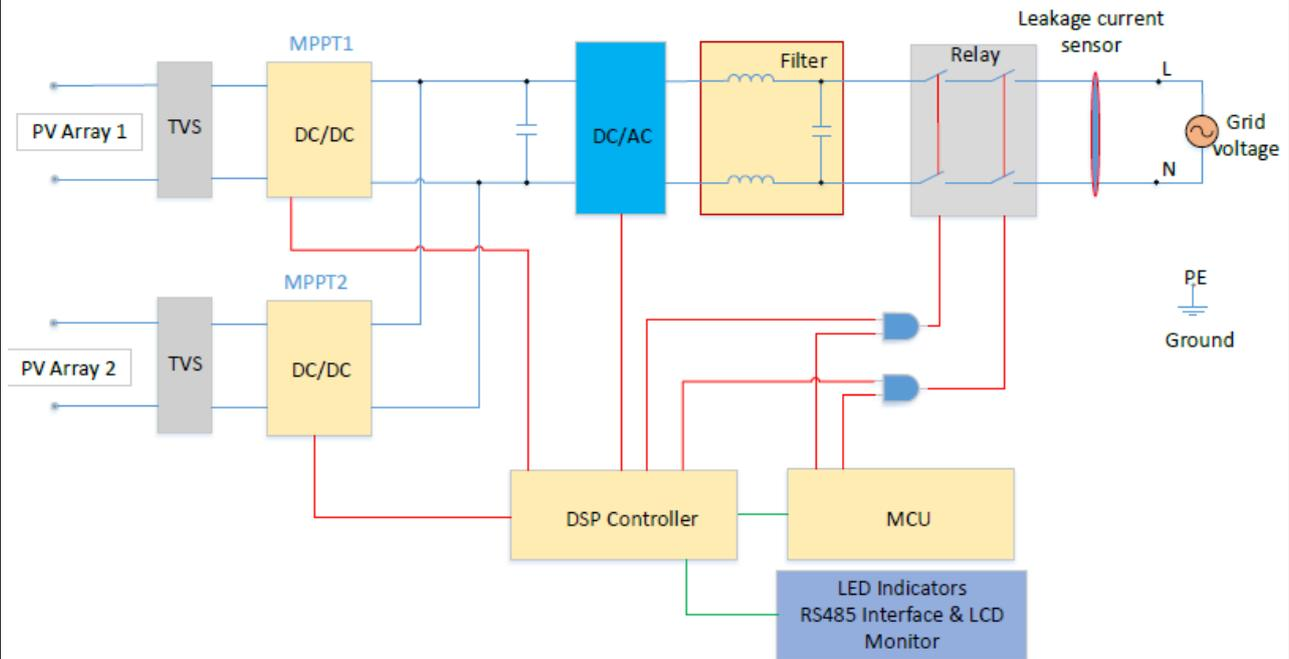

Model differences:

All models are identical and the output power is derating by software.

All models have same hardware and software except for the enclosure and output connector

For power 4-5KW with AC connector and for 6-10KW with AC terminal.

Other than special notice, for all clauses, the model HNS10000TL is type tested and valid for other models.

Copy of marking plate:

The artwork below may be only a draft. The use of certification marks on a product must be authorized by the respective certification body that own these marks.

Afore NEW ENERGY

Mode:	6000	7000	8000
HNSxxxTL	<input type="radio"/>	<input type="radio"/>	<input type="radio"/>
Pdc Max(W)	8400	9800	11200
Voc PV Max (V)	600		
Vdc MPPT(V)	70-550		
Idc Max (A)	14*2	14+26	14+26
Isc PV Max (A)	18*2	18+35	
Pac Nom (W)	6000	7000	8000
Iac Max (A)	28.7	33.6	38.3
Vac Nom (V)	L/N/PE, 220Vac, 230Vac, 240Vac		

Mode:	9000	10000
HNSxxxTL	<input type="radio"/>	<input type="radio"/>
Pdc Max(W)	12600	14000
Voc PV Max (V)	600	
Vdc MPPT(V)	70-550	
Idc Max (A)	26+26	
Isc PV Max (A)	35+35	
Pac Nom (W)	9000	10000
Iac Max (A)	45	50
Vac Nom (V)	L/N/PE, 220Vac, 230Vac, 240Vac	
Fac Nom(Hz)	50/60	
Power Factor	1 (-0.8~+0.8 adjustable)	
Protective Class	I	
Operating temperature range	-25~+60°C (Derating 45°C)	
IP Degree	IP65	

S/N

03.608000710010/V0.02

⚡ ⚠ ⚡ CE ⓧ ⓧ 5 min RoHS

+86-21-54326236 +86-21-54326136 Afore New Energy Technology (Shanghai) Co., Ltd.
www.aforeenergy.com info@aforeenergy.com Building 7, No.333 Wanfang Rd, Minhang District, Shanghai, China. 201112

Remark:

1 As Great Britain public Low Voltage Distribution Networks grid code G99 required, only 230 Vac / 50Hz output setting was verified in this test report.

2 Other labels are identical to above, except the model name and ratings

ER G99			
Clause	Requirement - Test	Result - Remark	Verdict
5	LEGAL ASPECTS	Shall be complied while installation	N/A
6	CONNECTION APPLICATION		N/A
7	CONNECTION ARRANGEMENTS		N/A
7.1	Operating Modes		N/A
7.2	Long-Term Parallel Operation		N/A
7.3	Infrequent Short-Term Parallel Operation		N/A
7.4	Switched Alternative-Only Operation		N/A
8	EARTHING	The Power Generating Module shall satisfy the requirements of DPC4 of the distribution code	N/A
9	Network Connection Design and Operation		P
9.1	General Criteria		N/A
9.1.1	As outlined in Section 5, DNOs have to meet certain statutory and Distribution Licence obligations when designing and operating their Distribution Networks. These obligations will influence the options for connecting Power Generating Modules.		N/A
9.1.2	The technical and design criteria to be applied in the design of the Distribution Network and Power Generating Module connection are detailed in this document and DPC 4 of the Distribution Code. The criteria are based upon the performance requirements of the Distribution Network necessary to meet the above obligations.		N/A
9.1.3	The Distribution Network, and any Power Generating Module connection to that network, shall be designed		P
	a. to comply with the obligations (to include security, frequency and voltage; voltage disturbances and harmonic distortion; auto reclosing and single phase protection operation).		P
	b. according to design principles in relation to Distribution Network's plant and equipment, earthing, voltage regulation and control, and protection as outlined in DPC4, subject to any Modification to which the DNO may reasonably consent.	The Power Generating Module shall satisfy the requirements of DPC4 of the distribution code	N/A
9.1.4	Power Generating Modules should meet a set of technical requirements in relation to its performance with respect to frequency and voltage, control capabilities, protection coordination requirements, Phase (Voltage) Unbalance requirements, neutral earthing provisions, islanding and Black Start Capability as applicable. The technical connection requirements in this chapter are common to all Power Generating Modules.	Only parts requirements comply with and test.	N/A
9.1.5	In addition requirements for Type A Power Generating Modules are detailed in Section 11. Requirements for Type B Power Generating Modules are detailed in Section 12. Requirements for Type C and Type D Power Generating Modules are detailed in Section 13.	Type A	P

ER G99			
Clause	Requirement - Test	Result - Remark	Verdict
9.1.6	The Reactive Power and voltage control requirements are given in Section 11, Section 12 and Section 13 for Type A Power Generating Modules, Type B Power Generating Modules, and Type C and Type D Power Generating Modules respectively.	Type A	P
9.1.7	Every Power Generating Module and any associated equipment must be designed and operated appropriately to comply with cyber security requirements	The Manufacturer of the Power Generating Module has provided a statement describing how the Power Generating Module has been designed to comply with cyber security	P
9.2	Network Connection Design for Power Generating Modules	NA on generating inverter	N/A
9.3	Step Voltage Change and Rapid Voltage Change		P
9.3.1	The Step Voltage Change and Rapid Voltage Change caused by the connection and disconnection of Power Generating Modules from the Distribution Network must be considered and be subject to limits to avoid unacceptable voltage changes being experienced by other Customers connected to the Distribution Network. The magnitude of a Step Voltage Change depends on the method of voltage control, types of load connected and the presence of local generation.	NA on generating inverter	N/A
9.3.2	Limits for Step Voltage Change and Rapid Voltage Change caused by the connection and disconnection of any Customers equipment to the Distribution Network should be within the limits set out in EREC P28.		N/A
9.3.3	The voltage depression arising from transformer magnetising inrush current is a short-time phenomenon captured by considerations of Rapid Voltage Change. In addition the size of the depression is dependent on the point on wave of switching and the duration of the depression is relatively short in that the voltage recovers substantially in less than 1 s.		N/A
9.3.4	Generator Installations shall be designed taking account of the advice in EREC P28 in respect of transformer energisation assessment such that transformer magnetising inrush current associated with normal routine switching operations does not cause voltage fluctuations outside those in EREC P28. To achieve this it may be necessary to install switchgear so that sites containing multiple transformers can be energised in stages.		N/A
9.3.5	These threshold limits shall be complied with at the Point of Common Coupling as required by EREC P28.		N/A
9.4	Power Quality		P
9.4.1	Introduction		--
9.4.1.1	The connection and operation of Power Generating Modules may cause Phase (Voltage) Unbalance and/or a distortion of the Distribution Network voltage waveform resulting in voltage fluctuations and harmonics.		--

ER G99			
Clause	Requirement - Test	Result - Remark	Verdict
9.4.2	Flick		P
9.4.2.1	Where the input motive power of the Power Generating Module may vary rapidly, causing corresponding changes in the output power, flicker may result. The operation of a Power Generating Module including synchronisation, run-up and desynchronisation shall not result in flicker that breaches the limits for flicker that is non-compliant with EREC P28.	Only consider the single generating inverter	P
9.4.2.2	The supply impedance of the Distribution Network needs to be considered to ensure that the emissions produced by the Power Generating Module do not cause a problem on the Distribution Network.		P
9.4.2.3	For Power Generating Modules up to 17 kW per phase or 50 kW three phase voltage step change and flicker measurements as required by BS EN 61000-3-11 shall be made and recorded in the test declaration form A2-1 or form A2-3 as applicable for the Power Generating Module. The DNO will use these declared figures to calculate the required maximum supply impedance required for the connection to comply with EREC P28. This calculation may show that the voltage fluctuations will be greater than those permitted and hence reinforcement of the Distribution Network may be required before the Power Generating Module can be connected. Detailed testing requirements are described in Annex A.7.		P
9.4.3	Harmonic Emissions		P
9.4.3.1	Harmonic currents produced within the Generator's system and modification of the harmonic impedance caused by the addition of the Generator's installation may cause excessive harmonic voltage distortion in the Distribution Network. The Generator's Installation must be designed and operated to comply with the planning criteria for harmonic voltage distortion as specified in EREC G5. EREC G5, like all planning standards referenced in this recommendation, is applicable at the time of connection of additional equipment to a Generator's Installation.		P
9.4.3.2	For Power Generating Modules of up to 17 kW per phase or 50 kW three phase harmonic measurements as required by BS EN 61000-3-12 shall be made and recorded in the test declaration form A2-1 or form A2-3 as applicable for the Power Generating Module. The DNO will use these declared figures to calculate the required maximum supply impedance required for the connection to comply with BS EN 61000-3-12 and will use this data in their design of the connection for the Power Generating Module. This standard requires a minimum ratio between source fault level and the size of the Power Generating Module, and connections in some cases may require the installation of a transformer between 2 and 4 times the rating of the Power Generating Module in order to accept the connection to a DNO's Distribution Network. Detailed testing requirements are described in Annex A.7	Comply with BS EN 61000-3-12	P

ER G99			
Clause	Requirement - Test	Result - Remark	Verdict
9.4.3.3	Where the Power Generating Module is connected via a long cable circuit the likelihood of a resonant condition is greatly increased, especially at 132 kV. This arises from the reaction of the transformer inductance with the cable capacitance. Resonance is likely in the low multiples of the fundamental frequency (8th-11th harmonic). The resonant frequency is also a function of the Total System fault level. If there is the possibility that this can change significantly eg by the connection of another Power Generating Module then a full harmonic study should be carried out.		N/A
9.4.4	Voltage imbalance	Single phase inverter	N/A
9.4.4.1	EREC P29 is a planning standard which provides limits for voltage unbalance caused by uneven loading of three phase supply systems. Power Generating Modules should be capable of performing satisfactorily under the conditions it defines. The existing voltage unbalance on an urban Distribution Network rarely exceeds 0.5% but higher levels, in excess of 1%, may be experienced at times of high load and when outages occur at voltage levels above 11 kV. 1% may exist continuously due to unbalance of the system impedance (common on remote rural networks). In addition, account can be taken of the neutralising effect of rotating plant, particularly at 11 kV and below. BS EN 50160 contains details of the variations and disturbances to the voltage which shall be taken into account in selecting equipment from an appropriate specification for installation on or connected to the Distribution Network.		N/A
9.4.4.2	The level of voltage unbalance at the Point Of Common Coupling should be no greater than 1.3% for systems with a nominal voltage below 33 kV, or 1% for other systems with a nominal voltage no greater than 132 kV. Overall, voltage unbalance should not exceed 2% when assessed over any one minute period. EREC P29, like all planning standards, is applicable at the time of connection.		N/A
9.4.4.3	For Power Generating Facilities of 50 kW or less Section 7.5 of this document specifies maximum unbalance of Power Generating Modules. Where these requirements are met then no further action is required by the Generator.		N/A
9.4.5	Power Factor correction equipment is sometimes used with Power Park Modules to decrease Reactive Power flows on the Distribution Network. Where the Power Factor correction equipment is of a fixed output, stable operating conditions in the event of loss of the DNO supply are extremely unlikely to be maintained, and therefore no special protective actions are required in addition to the standard protection specified in this document.		P
9.4.6	DC Injection		P
9.4.6.1	The effects of, and therefore limits for, DC currents injected into the Distribution Network is an area currently under investigation. Until these investigations are concluded the limit for DC injection is less than 0.25% of the AC rating per Power Generating Module.		P
9.4.6.2	The main source of these emissions are from transformer-less Inverters. Where necessary DC emission requirements can be satisfied by installing a transformer on the AC side of an Inverter.		N/A

ER G99			
Clause	Requirement - Test	Result - Remark	Verdict
9.5	System Stability	NA on generating inverter	N/A
9.6	Island Mode	It is depend on DNO	N/A
9.7	Fault Contributions and Switchgear Considerations	NA on generating inverter	N/A
10	PROTECTION		P
10.1	General		P
10.1.1	The main function of the protection systems and settings described in this document is to prevent the Power Generating Module supporting an islanded section of the Distribution Network when it would or could pose a hazard to the Distribution Network or Customers connected to it. The settings recognize the need to avoid nuisance tripping and therefore require a two stage approach where practicable, ie to have a long time delay for smaller excursions that may be experienced during normal Distribution Network operation, to avoid nuisance tripping, but with a faster trip, where possible, for greater excursions.	Only considered on inverter	P
10.1.2	In accordance with established practice it is for the Generator to install, own and maintain this protection. The Generator can therefore determine the approach, ie per Power Generating Module or per installation, and where in the installation the protection is sited.		N/A
10.1.3	Where a common protection system is used to provide the protection function for multiple Power Generating Modules the complete installation cannot be considered to comprise Fully Type Tested Power Generating Modules if the protection and connections are made up on site and so cannot be factory tested or Type Tested. If the units or Power Generating Modules are specifically designed to be interconnected on site via plugs and sockets, then provided the assembly passes the function tests required in Annex A.2 (Form A2-4), the Power Generating Modules can retain Type Tested status.	Only considered on inverter	P
10.1.4	Type Tested Interface Protection shall have protection settings set during manufacture.		P
10.1.5	Once the Power Generating Modules has been installed and commissioned the protection settings shall only be altered following written agreement between the DNO and the Generator.		P
10.1.6	In exceptional circumstances additional protection may be required by the DNO to protect the Distribution Network and its Customers from the Power Generating Module.		P
10.1.7	Note that where the Generator installs an Export Limiting Scheme in accordance with EREC G100 the installation will also need to comply with the requirements of that EREC.		N/A
10.2	Co-ordinating with DNO's Distribution Network's Existing Protection		N/A
10.2.1	It will be necessary for the protection associated with Power Generating Modules to co-ordinate with the Protection associated with the DNO's Distribution Network as follows:		N/A

ER G99			
Clause	Requirement - Test	Result - Remark	Verdict
	<p>For Power Generating Modules directly connected to the DNO's Distribution Network the Power Generating Module must meet the target clearance times for fault current interchange with the DNO's Distribution Network in order to reduce to a minimum the impact on the DNO's Distribution Network of faults on circuits owned by the Generator.</p> <p>The DNO will ensure that the DNO protection settings meet its own target clearance times.</p> <p>The target clearance times are measured from fault current inception to arc extinction and will be specified by the DNO to meet the requirements of the relevant part of the Distribution Network.</p>		N/A
	<p>The settings of any protection controlling a circuit breaker or the operating values of any automatic switching device at any point of connection with the DNO's Distribution Network, as well as the Generator's maintenance and testing regime, shall be agreed between the DNO and the Generator in writing during the connection consultation process.</p>		N/A
	<p>It will be necessary for the Power Generating Module protection to co-ordinate with any auto-reclose policy specified by the DNO. In particular the Power Generating Module protection should detect a loss of mains situation and disconnect the Power Generating Module in a time shorter than any auto reclose dead time. This should include an allowance for circuit breaker operation and generally a minimum of 0.5 s should be allowed for this. For auto-reclosers set with a dead time of 3 s, this implies a maximum Interface Protection response time of 2.5 s. Where auto-reclosers have a dead time of less than 3 s, there may be a need to reduce the operating time of the Interface Protection. For Type Tested Power Park Modules no changes are required to the operating times irrespective of the auto-reclose times. In all other cases where the auto-recloser dead time is less than 3 s the Generator will need to agree site-specific Interface Protection settings with the DNO.</p>		N/A
10.2.2	Specific protection required for Power Generating Modules		P
	In addition to any protection installed by the Generator to meet the requirements of the Power Generating Facility and statutory obligations, the Generator shall install protection to achieve the following objectives		P
	(a) For all Power Generating Modules:		P
	i. To disconnect the Power Generating Module from the system when a system abnormality occurs that results in an unacceptable deviation of the frequency or voltage at the Connection Point, recognizing the requirements to ride through faults as detailed in Sections 12.3 and 13.4;		P
	ii. To ensure the automatic disconnection of the Power Generating Module or Generating Unit, or where there is constant supervision of an installation, the operation of an alarm with an audio and visual indication, in the event of any failure of supplies to the protective equipment that would inhibit its correct operation.		P
	(b) For polyphase Power Generating Modules:		N/A

ER G99			
Clause	Requirement - Test	Result - Remark	Verdict
	i.To inhibit connection of Power Generating Modules to the system unless all phases of the DNO's Distribution Network are present and within the agreed ranges of protection settings;		N/A
	ii. To disconnect the Power Generating Module from the system in the event of the loss of one or more phases of the DNO's Distribution Network;		N/A
	(c) For single phase Power Generating Modules:		P
	i. To inhibit connection of Power Generating Modules to the system unless that phase of the DNO's Distribution Network is present and within the agreed ranges of protection settings;		P
	ii. To disconnect the Power Generating Module from the system in the event of the loss of that phase of the DNO's Distribution Network;		P
10.3	Protection Requirements		P
10.3.1	Suitable protection arrangements and settings will depend upon the particular Generator installation and the requirements of the DNO's Distribution Network. These individual requirements must be ascertained in discussions with the DNO. To achieve the objectives above, the protection must include the detection of: <ul style="list-style-type: none"> • UnderVoltage (1 stage); • OverVoltage (2 stage); • UnderFrequency (2 stage); • OverFrequency (1 stage); • Loss of Mains (LoM). 		P
	The LoM protection will depend for its operation on the detection of some suitable parameter, for example, rate of change of frequency (RoCoF), or unbalanced voltages. More details on LoM protection are given in Section 10.4.		P
	There are different protection settings dependent upon the system voltage at which the Power Generating Module is connected (LV or HV).	Only considered LV connection	P
	Protection settings for Power Generating Facilities over 100 MW Registered Capacity must be consistent with Grid Code requirements. Loss of Mains protection will only be permitted at these sites if sanctioned by the NETSO– see Section 10.4.2 below.		N/A
	It is in the interest of Generators, DNOs and NETSO that Power Generating Modules remains synchronised to the Distribution Network during system disturbances, and conversely to disconnect reliably for true LoM situations. Frequency and voltage excursions less than the protection settings should not cause protection operation. As some forms of LoM protection might not readily achieve the required level of performance (eg under balanced load conditions), the preferred method for Power Generating Facilities with a Registered Capacity greater than 50 MW is by means of intertripping. This does not preclude consideration of other methods that may be more appropriate for a particular connection.		N/A
10.3.2	The protective equipment, provided by the Generator, to meet the requirements of this section must be installed in a suitable location that affords visual inspection of the protection settings and trip indicators and is secure from interference by unauthorised personnel.		P

ER G99			
Clause	Requirement - Test	Result - Remark	Verdict
10.3.3	Installation of automatic reconnection systems for Type B, Type C and Type D shall be subject to prior authorisation by the DNO. Unless Generators of Type D Power Generating Modules have prior authorisation from the DNO for the installation of automatic reconnection systems, they must obtain authorisation from the DNO, or NETSO as applicable, prior to synchronisation.	Type A considered	N/A
10.3.4	The frequency and voltage at the DNO's side of the supply terminals at the Connection Point must be within the frequency and voltage ranges of the Interface Protection as listed in paragraph 10.6.7 for at least 20 s before the Power Generating Module is allowed to automatically reconnect to the DNO's Distribution Network. There is in general no maximum admissible ramp rate for Active Power output on connecting or reconnecting, although it is a requirement to state the assumed maximum ramp rate for the Power Generating Module as part of the application for connection. If a network specific issue requires a maximum admissible ramp rate of Active Power output on connection it will be specified by in the Connection Agreement.		P
10.3.5	If automatic resetting of the protective equipment is used, there must be a time delay to ensure that healthy supply conditions exist for a minimum continuous period of 20 s. Reset times may need to be co-ordinated where more than one Power Generating Module is connected to the same feeder. The automatic reset must be inhibited for faults on the Generator's Installation.		P
10.3.6	Protection equipment is required to function correctly within the environment in which it is placed and shall satisfy the following standards: <ul style="list-style-type: none"> • BS EN 61000 (Electromagnetic Standards); • BS EN 60255 (Electrical Relays); • BS EN 61810 (Electrical Elementary Relays); • BS EN 60947 (Low Voltage Switchgear and Control gear); • BS EN 61869 (Instrument Transformers; Additional requirements for current transformers). Where these standards have more than one part, the requirements of all such parts shall be satisfied, so far as they are applicable.		P
10.3.7	Protection equipment and protection functions may be installed within, or form part of the Power Generating Module control equipment as long as:		P
	the control equipment satisfies all the requirements of Section 10 including the relevant standards specified in paragraph 10.3.6;		P
	the Power Generating Module shuts down in a controlled and safe manner should there be an equipment failure that affects both the protection and control functionality, for example a power supply failure or microprocessor failure; and		P
	the equipment is designed and installed so that protection calibration and functional tests can be carried out easily and safely using secondary injection techniques (ie using separate Low Voltage test equipment).		P
10.4	Loss of Mains (LoM)		P

ER G99			
Clause	Requirement - Test	Result - Remark	Verdict
10.4.1	To achieve the objectives of Section 10.1.1, in addition to protection installed by the Generator for his own purposes, the Generator must install protection to achieve (amongst other things) disconnection of the Power Generating Module from the Distribution Network in the event of loss of one or more phases of the DNOs supply. This LoM protection is required to ensure that the Power Generating Module is disconnected, to ensure that the requirements for Distribution Network earthing, and out-of-Synchronism closure are complied with and that Customers are not supplied with voltage and frequencies outside statutory limits.		P
10.4.2	LoM protection is required for all Type A, Type B and Type C Power Generating Modules. For Type D Power Generating Modules the DNO will advise if LoM protection is required. The requirements of paragraph 10.6.2 apply to LoM protection for all Power Generating Modules.		P
10.4.3	A problem can arise for Generators who operate a Power Generating Module in parallel with the Distribution Network prior to a failure of the network supply because if their Power Generating Module continues to operate in some manner, even for a relatively short period of time, there is a risk that when the network supply is restored the Power Generating Module will be out of Synchronism with the Total System and suffer damage. LoM protection can be employed to disconnect the Power Generating Module immediately after the supply is lost, thereby avoiding damage to the Power Generating Module.		P
10.4.4	Where the amount of Distribution Network load that the Power Generating Module will attempt to pick up following a fault on the Distribution Network is significantly more than its capability the Power Generating Module will rapidly disconnect, or stall. However, depending on the exact conditions at the time of the Distribution Network failure, there may or may not be a sufficient change of load on the Power Generating Module to be able to reliably detect the failure. The Distribution Network failure may result in one of the following load conditions being experienced by the Power Generating Module:		P
	(a) The load may slightly increase or reduce, but remain within the capability of the Power Generating Module. There may even be no change of load;		P
	(b) The load may increase above the capability of the prime mover, in which case the Power Generating Module will slow down, even though the alternator may maintain voltage and current within its capacity. This condition of speed/frequency reduction can be easily detected; or		P
	(c) The load may increase to several times the capability of the Power Generating Module, in which case the following easily detectable conditions will occur: <ul style="list-style-type: none"> • Overload and accompanying speed/frequency reduction • Over current and under voltage on the alternator 		P

ER G99			
Clause	Requirement - Test	Result - Remark	Verdict
10.4.5	Conditions (b) and (c) are easily detected by the under and over voltage and frequency protection required in this document. However, condition (a) presents most difficulty, particularly if the load change is extremely small and therefore there is a possibility that part of the Distribution Network supply being supplied by the Power Generating Module will be out of Synchronism with the Total System. LoM protection is designed to detect these conditions.		P
10.4.6	LoM signals can also be provided by means of intertripping signals from circuit breakers that have operated in response to the Distribution Network fault.		N/A
10.4.7	The LoM protection can utilise one or a combination of the passive protection principles such as reverse Active Power flow, reverse Reactive Power and rate of change of frequency (RoCoF). Alternatively, active methods such as reactive export error detection or frequency shifting may be employed. These may be arranged to trip the interface circuit breaker at the DNO Generator interface, thus, leaving the Power Generating Module available to satisfy the load requirements of the site or the Power Generating Module circuit breaker can be tripped, leaving the breaker at the interface closed and ready to resume supply when the Distribution Network supply is restored. The most appropriate arrangement is subject to agreement between the DNO and Generator.	Active and passive protection	P
10.4.8	Protection based on measurement of reverse flow of Active Power or Reactive Power can be used when circumstances permit and must be set to suit the Power Generating Module rating, the site load conditions and requirements for Reactive Power.		N/A
10.4.9	Where the Power Generating Facility capacity is such that the site will always import power from the Distribution Network, a reverse power relay may be used to detect failure of the supply. It will usually be appropriate to monitor all three phases for reverse power.		N/A
10.4.10	However, where the Power Generating Facilities normal mode of operation is to export power, it is not possible to use a reverse power relay and consequently failure of the supply cannot be detected by measurement of reverse power flow. The protection should then be specifically designed to detect loss of the mains connection using techniques to detect the rate of change of frequency and/or Power Factor. All these techniques are susceptible to Distribution Network conditions and the changes that occur without islanding taking place. These relays must be set to prevent islanding but with the best possible immunity to unwanted nuisance operation.		P
10.4.11	RoCoF relays use a measurement of the period of the mains voltage cycle. The RoCoF technique measures the rate of change in frequency caused by any difference between prime mover power and electrical output power of the Power Generating Module over a number of cycles. RoCoF relays should normally ignore the slow changes but respond to relatively rapid changes of frequency which occur when the Power Generating Module becomes disconnected from the Total System. The voltage vector shift technique is not an acceptable loss of mains protection.		P

ER G99			
Clause	Requirement - Test	Result - Remark	Verdict
10.4.12	Should spurious tripping present a nuisance to the Generator, the cause must be jointly sought with the DNO. Raising settings on any relay to avoid spurious operation may reduce a relay's capability to detect islanding and it is important to evaluate fully such changes. Annex D.2 provides some guidance for assessments, which assume that during a short period of islanding the trapped load is unchanged. In some circumstances it may be necessary to employ a different technique, or a combination of techniques to satisfy the conflicting requirements of safety and avoidance of nuisance tripping. In those cases where the DNO requires LoM protection this must be provided by a means not susceptible to spurious or nuisance tripping, eg intertripping.		P
10.4.13	For a radial or simple Distribution Network controlled by circuit breakers that would clearly disconnect the entire circuit and associated Power Generating Module, for a LoM event an intertripping scheme can be easy to design and install. For meshed or ring Distribution Networks, it can be difficult to define which circuit breakers may need to be incorporated in an intertripping scheme to detect a LoM event and the inherent risks associated with a complex system should be considered alongside those associated with a using simple, but potentially less discriminatory LoM relay.		N/A
10.4.14	It is the responsibility of the Generator to incorporate what they believe to be the most appropriate technique or combination of techniques to detect a LoM event in his protection systems. This will be based on knowledge of the Power Generating Module, site and network load conditions. The DNO will assist in the decision making process by providing information on the Distribution Network and its loads. The settings applied must be biased to ensure detection of islanding under all practical operating conditions.		P
10.5	Additional DNO Protection	Shall be considered in the end installation	N/A
10.6	Protection Settings		P
10.6.1	The following notes aim to explain the settings requirements as given in Section 10.6.7 below.		P
10.6.2	Loss of Mains		P
	A LoM protection of the RoCoF type will generally be appropriate for Type A, Type B and Type C Power Generating Modules, but this type of LoM protection must not be installed for Power Generating Facilities at or above 50 MW. In those cases where the DNO requires LoM protection this must be provided by a means not susceptible to spurious or nuisance tripping, eg intertripping.		P
10.6.3	Under Voltage		P

ER G99			
Clause	Requirement - Test	Result - Remark	Verdict
	In order to help maintain Total System Stability, the protection settings aim to facilitate transmission fault ride through capability (as required in Sections 12.3 and 13.3 below). The overall aim is to ensure that Power Generating Module is not disconnected from the Distribution Network unless there is material disturbance on the Distribution Network, as disconnecting generation unnecessarily will tend to make an under voltage situation worse. To maximize the transmission fault ride through capability a single undervoltage setting of - 20% with a time delay of 2.5 s should be applied.		P
10.6.4	Over Voltage		P
	Over voltages are potentially more dangerous than under voltages and hence the acceptable excursions from the norm are smaller and time delays shorter, a 2-Stage over voltage protection ⁶ is to be applied		P
	<p>Stage 1 (LV) should have a setting of +14% (ie the LV statutory upper voltage limit of +10%,with a further 4% permitted for voltage rise internal to the Customer's installation and measurement errors),with a time delay of 1.0s (to avoid nuisance tripping for short duration excursions);</p> <ul style="list-style-type: none"> • Stage 2 (LV) should have a setting of +19% with a time delay of 0.5s (ie recognising the need to disconnect quickly for a material excursion); 		P
	<p>Stage 1 (HV) should have a setting of +10% with a time delay of 1.0s (ie the HV statutory upper voltage limit of +6%,with a further 4% permitted for voltage rise internal to the Customers Installation and measurement errors),, with a time delay of 1.0s to avoid nuisance tripping for short duration excursions);</p> <ul style="list-style-type: none"> • Stage 2 (HV) should have a setting of +13% with a time delay of 0.5s (ie recognising the need to disconnect quickly for a material excursion). 		N/A
	To achieve high utilisation and Distribution System efficiency, it is common for the HV Distribution System to be normally operated near to the upper statutory voltage limits. The presence of Generating Plant within such Distribution Systems may increase the risk of the statutory limit being exceeded, e.g. when the Distribution System is operating abnormally. In such cases the DNO may specify additional over voltage protection at the Generating Plant connection point. This protection will typically have an operating time delay long enough to permit the correction of transient over voltages by automatic tap-changers.		N/A
10.6.5	Over Frequency		P

ER G99			
Clause	Requirement - Test	Result - Remark	Verdict
	Power Generating Modules are required to stay connected to the Total System for frequencies up to 52 Hz for up to 15 minutes so as to provide the necessary regulation to control the Total System frequency to a satisfactory level. In order to prevent the unnecessary disconnection of a large volume of smaller Power Generating Module for all LV and HV connected Power Generating Module a single stage protection is to be applied that has a time delay of 0.5 s and a setting of 52 Hz. If the frequency rises to or above 52 Hz as the result of an undetected islanding condition, the Power Generating Module will be disconnected with a delay of 0.5 s plus circuit breaker operating time.		P
10.6.6	Under Frequency		P
	All Power Generating Facilities are required to maintain connection unless the Total System frequency falls below 47.5 Hz for 20 s or below 47 Hz.		P
	For all LV and HV connected Generating Plant, the following 2-stage under frequency protection should be applied:		P
	• Stage 1 should have a setting of 47.5 Hz with a time delay of 20s;		P
	• Stage 2 should have a setting of 47.0 Hz with a time delay of 0.5s;		P
10.6.7	Protection Settings		P
10.6.7.1	Settings for Long-Term Parallel Operation		P
10.6.7.2	Settings for Infrequent Short-Term Parallel Operation		N/A
10.6.8	Over and Under voltage protection must operate independently for all three phases in all cases.		N/A
10.6.9	The settings in Table 10.1 should generally be applied to all Power Generating Modules. In exceptional circumstances Generators have the option to agree alternative settings with the DNO if there are valid justifications in that the Power Generating Module may become unstable or suffer damage with the settings specified in Table 10.1. The agreed settings should be recorded in the Connection Agreement.		N/A
10.6.10	Once the settings of relays have been agreed between the Generator and the DNO they must not be altered without the written agreement of the DNO. Any revised settings should be recorded again in the amended Connection Agreement.		P
10.6.11	The under/over voltage and frequency protection may be duplicated to protect the Power Generating Module when operating in island mode although different settings may be required.		P
10.6.12	For LV connected Power Generating Modules the voltage settings will be based on the 230 V nominal system voltage. In some cases Power Generating Modules may be connected to LV systems with non-standard operating voltages. Paragraph 10.6.14 details how suitable settings can be calculated based upon the HV connected settings in Table 10.1. Note that Power Generating Modules with non-standard LV protection settings need to be agreed by the DNO on a case by case basis.		N/A

ER G99			
Clause	Requirement - Test	Result - Remark	Verdict
10.6.13	Where an installation contains Power Factor correction equipment which has a variable susceptance controlled to meet the Reactive Power demands, the probability of sustained generation is increased. For LV installations, additional protective equipment provided by the Generator, is required as in the case of self-excited asynchronous machines.		N/A
10.6.14	Non-Standard private LV networks calculation of appropriate protection settings		N/A
10.6.15	The Generator shall provide a means of displaying the protection settings so that they can be inspected if required by the DNO to confirm that the correct settings have been applied. The Manufacturer needs to establish a secure way of displaying the settings in one of the following ways:	The way (b) is used	P
	(a) A display on a screen which can be read;		N/A
	(b) A display on an electronic device which can communicate with the Power Generating Module and confirm that it is the correct device by means of a Identification number / name permanently fixed to the device and visible on the electronic device screen at the same time as the settings;		P
	(c) Display of all settings including nominal voltage and current outputs, alongside the identification number / name of the device, permanently fixed to the Power Generating Module.		N/A
	The provision of loose documents, documents attached by cable ties etc., a statement that the device conforms with a standard, or provision of data on adhesive paper based products which are not likely to survive due to fading, or failure of the adhesive, for at least 20 years is not acceptable. The protection arrangements (including changes to protection arrangements) for individual schemes will be agreed between the Generator and the DNO in accordance with this document.		P
10.6.16	Whilst the protection schemes and settings for internal electrical faults should mitigate any damage to the Power Generating Module they must not jeopardise the performance of a Power Generating Module, in line with the requirements set out in this EREC.		P
10.6.17	The Generator shall organise its protection and control devices in accordance with the following priority ranking (from highest to lowest) for Type B, Type C and Type D Power Generating Modules:	Type A	N/A
10.6.18	For the avoidance of doubt where an internal fault on the Power Generating Module occurs during any significant event on the Total System, the Power Generating Module's internal protection should trip the module to ensure safety and minimise damage to the Power Generating Module.		P
10.7	Typical Protection Application Diagrams		N/A
11	Type A Power Generating Module Technical Requirements		P
11.1	Power Generating Module Performance and Control Requirements – General		P

ER G99			
Clause	Requirement - Test	Result - Remark	Verdict
11.1.1	The requirements of this Section 11 do not apply in full to Power Generation Facilities that are designed and installed for infrequent short term parallel operation only nor to storage Power Generation Modules within the Power Generating Facility – refer to Annex A.4.		P
11.1.2	The Active Power output of a Power Generating Module should not be affected by voltage changes within the statutory limits declared by the DNO in accordance with the ESQCR.		P
11.1.3	Power Generating Modules connected to the DNO's Distribution Network shall be equipped with a logic interface (input port) in order to cease Active Power output within 5 s following an instruction being received at the input port.		P
11.1.3.1	By default the DNO logic interface will take the form of a simple binary output that can be operated by a simple switch or contactor. When the switch is closed the Power Generating Module can operate normally. When the switch is opened the Power Generating Module will reduce its Active Power to zero within 5 s. The signal from the Power Generating Module that is being switched can be either AC (maximum value 240 V) or DC (maximum value 110 V). If the DNO wishes to make use of the facility to cease Active Power output the DNO will agree with the Generator how the communication path is to be achieved.		P
11.1.4	Each item of a Power Generating Module and its associated control equipment must be designed for stable operation in parallel with the Distribution Network.		P
11.1.5	When operating at rated power the Power Generating Module shall be capable of operating at a Power Factor within the range 0.95 lagging to 0.95 leading relative to the voltage waveform unless otherwise agreed with the DNO.		P
11.1.6	As part of the connection application process the Generator shall agree with the DNO the set points of the control scheme for voltage control, Power Factor control or Reactive Power control as appropriate. These settings, and any changes to these settings, shall be agreed with the DNO and recorded in the Connection Agreement. The information to be provided is detailed in Schedule 5a and Schedule 5b of the Data Registration Code.		N/A
11.1.7	Load flow and System Stability studies may be necessary to determine any output constraints or post fault actions necessary for n-1 fault conditions and credible n-2 conditions (where n-1 and n-2 conditions are the first and second outage conditions as, for example, specified in EREC P2) involving a mixture of fault and planned outages. The Connection Agreement should include details of the relevant outage conditions. It may be necessary under these fault conditions, where the combination of Power Generating Module output, load and through flow levels leads to circuit overloading, to rapidly disconnect or constrain the Power Generating Module.		N/A
11.2	Frequency response		P

ER G99			
Clause	Requirement - Test	Result - Remark	Verdict
11.2.1	<p>Under abnormal conditions automatic low-frequency load-shedding provides for load reduction down to 47 Hz. In exceptional circumstances, the frequency of the DNO's Distribution Network could rise above 50.5 Hz. Therefore all Power Generating Modules should be capable of continuing to operate in parallel with the Distribution Network in accordance with the following:</p> <p>(a) 47 Hz – 47.5 Hz Operation for a period of at least 20 s is required each time the frequency is within this range.</p> <p>(b) 47.5 Hz – 49.0 Hz Operation for a period of at least 90 minutes is required each time the frequency is within this range.</p> <p>(c) 49.0 Hz – 51.0 Hz Continuous operation of the Power Generating Module is required.</p> <p>(d) 51.0 Hz – 51.5 Hz Operation for a period of at least 90 minutes is required each time the frequency is within this range.</p> <p>(e) 51.5 Hz – 52 Hz Operation for a period of at least 15 minutes is required each time the frequency is within this range.</p>		P
11.2.2	<p>With regard to the rate of change of frequency withstand capability, a Power Generating Module shall be capable of staying connected to the Distribution Network and operate at rates of change of frequency up to 1 Hzs-1 as measured over a period of 500 ms unless disconnection was triggered by a rate of change of frequency type loss of mains protection or by the Power Generating Module's own protection system for a co-incident internal fault as detailed in paragraph 10.6.18.</p>		P
11.2.3	Output power with falling frequency		P
11.2.3.1	Each Power Generating Module, must be capable of:		P
	(a) continuously maintaining constant Active Power output for system frequency changes within the range 50.5 to 49.5 Hz; and		P
	(b) (subject to the provisions of paragraph 11.2.1) maintaining its Active Power output at a level not lower than the figure determined by the linear relationship shown in Figure 11.1 for system frequency changes within the range 49.5 to 47 Hz for all ambient temperatures up to and including 25°C, such that if the system frequency drops to 47 Hz the Active Power output does not decrease by more than 5%.		P
11.2.3.2	For the avoidance of doubt in the case of a Power Generating Module using an Intermittent Power Source where the power input will not be constant over time, the requirement is that the Active Power output shall be independent of system frequency under (a) above and should not drop with system frequency by greater than the amount specified in (b) above.		P
11.2.4	Limited Frequency Sensitive Mode – Over frequency		P
11.2.4.1	Each Power Generating Module shall be capable of reducing Active Power output in response to frequency on the Total System when this rises above 50.4 Hz. The Power Generating Module shall be capable of operating stably during LFSM-O operation. If a Power Generating Module has been contracted to operate in Frequency Sensitive Mode the requirements of LFSM-O shall apply when frequency exceeds 50.5 Hz.		P

ER G99			
Clause	Requirement - Test	Result - Remark	Verdict
	(a).The rate of change of Active Power output must be at a minimum a rate of 2% of output per 0.1 Hz deviation of system frequency above 50.4 Hz (ie a Droop of 10%) as shown in Figure 11.2. For the avoidance of doubt, this would not preclude a Generator from designing their Power Generating Module with a Droop of less than 10%, but in all cases the Droop should be 2% or greater.		P
	(b) The Power Generating Module shall be capable of initiating a power frequency response with an initial delay that is as short as possible. If the initial delay exceeds 2 s the Generator shall justify the delay, providing technical evidence to the DNO, who will pass this evidence to the NETSO. As much as possible of the proportional reduction in Active Power output must result from the frequency control device (or speed governor) action and must be achieved within 10 s of the time of the frequency increase above 50.4 Hz.		P
	(c) If the reduction in Active Power is such that the Power Generation Module reaches its Minimum Generation, it must continue to operate stably at this level.		P
11.2.4.2	When the Power Generating Module is providing Limited Frequency Sensitive Mode Over frequency (LFSM-O) response it must continue to provide the frequency response until the frequency has returned to, or is below, 50.4 Hz.		P
11.2.4.3	Steady state operation below Minimum Generation is not expected but if system operating conditions cause operation below Minimum Generation which give rise to operational difficulties then the Generator shall be able to return the output of the Power Generating Module to an output of not less than the Minimum Generation.		P
11.3	Fault Ride Through and Phase Voltage Unbalance		N/A
11.3.1	Where it has been specifically agreed between the DNO and the Generator that a Power Generating Facility will contribute to the DNO's Distribution Network security, (eg for compliance with EREC P2) the Power Generating Module(s) may be required to withstand, without tripping, the effects of a close up three phase fault and the Phase (Voltage) Unbalance imposed during the clearance of a close-up phase-to-phase fault, in both cases cleared by the DNO's main protection. The DNO will advise the Generator in each case of the likely tripping time of the DNO's protection, and for phase-phase faults, the likely value of Phase (Voltage) Unbalance during the fault clearance time.		N/A
11.3.2	In the case of phase to phase faults on the DNO's system that are cleared by system back-up protection which will be within the plant short time rating on the DNO's Distribution Network the DNO, on request during the connection process, will advise the Generator of the expected Phase (Voltage) Unbalance.		N/A
11.4	Voltage Limits and Control		N/A

ER G99			
Clause	Requirement - Test	Result - Remark	Verdict
11.4.1	Where a Power Generating Module is remote from a Network voltage control point it may be required to withstand voltages outside the normal statutory limits. In these circumstances, the DNO should agree with the Generator the declared voltage and voltage range at the Connection Point. Immunity of the Power Generating Module to voltage changes of $\pm 10\%$ of the declared voltage is recommended, subject to design appraisal of individual installations.		N/A
11.4.2	The connection of a Power Generating Module to the Distribution Network shall be designed in such a way that operation of the Power Generating Module does not adversely affect the voltage profile of and voltage control employed on the Distribution Network. ETR 126 provides DNOs with guidance on active management solutions to overcome voltage control limitations. Information on the voltage regulation and control arrangements will be made available by the DNO if requested by the Generator.		N/A
11.4.3	The final responsibility for control of Distribution Network voltage does however remain with the DNO.		N/A
11.4.4	Automatic Voltage Control (AVC) schemes employed by the DNO often assume that power flows from parts of the Distribution Network operating at a higher voltage to parts of the Distribution Network operating at lower voltages. Export from Power Generating Modules in excess of the local loads may result in power flows in the reverse direction. In this case AVC referenced to the low voltage side may not operate correctly without an import of Reactive Power and relay settings appropriate to this operating condition. When load current compounding is used with the AVC and the penetration level of Power Generating Modules becomes significant compared to normal loads, it may be necessary to switch any compounding out of service.		N/A
11.4.5	Power Generating Modules can cause problems if connected to networks employing AVC schemes which use negative reactance compounding and line drop compensation due to changes in Active Power and Reactive Power flows. ETR 126 provides guidance on connecting generation to such networks using techniques such as removing the generation circuit from the AVC scheme using cancellation CTs.		N/A
12	Type B Power Generating Module Technical Requirements		N/A
13	Type C and Type D Power Generating Module Technical Requirements		N/A
14	Installation, Operation and Control Interface		N/A
15	Common Compliance and Commissioning Requirements for all Power Generating Modules		N/A
16	Type A Compliance Testing, Commissioning and Operational Notification		P
16.1	Type Test Certification		P
	The Power Generating Module can comprise Fully Type Tested equipment or be made up of some Type Tested equipment and require additional site testing prior to operation. The use of Fully Type Tested equipment simplifies the connection process, the protection arrangements and reduces the commissioning test requirements.	Type test equipment	N/A

ER G99			
Clause	Requirement - Test	Result - Remark	Verdict
16.1.2	Type Tested certification is the responsibility of the Manufacturer. The Manufacturer shall submit the Type Test Verification Report confirming that the product has been Type Tested to satisfy the requirements of this EREC G99 to the Energy Networks Association (ENA) Type Test Verification Report Register. The report shall detail the type and model of product tested, the test conditions and results recorded. The report can include reference to Manufacturers' Information. Examples of the combination of the use of type testing and the provision of Manufacturers' Information are given in Section 22.1. Further information about Manufacturers' Information in respect of Power Park Modules is given in Section 21. A Manufacturer of a Type Tested product should allocate a Manufacturer's reference number, which should be registered on the ENA Type Test Verification Report Register as the Product ID.		P
16.1.3	The required Type Test Verification Report and declarations including that for a Fully Type Tested Power Generating Module are shown in Annex A.2:	Form A2-3 used	P
16.1.4	Guidance for Manufacturers on type testing for Power Generating Modules is included in Annex A.7 of this document.		P
16.1.5	Compliance with the requirements detailed in this EREC G99 will ensure that the Power Generating Module is considered to be approved for connection to the DNO's Distribution Network.		N/A
16.1.6	The Power Generating Module shall comply with all relevant European Directives and should be labelled with a corresponding CE marking.		P
16.2	Connection Process		N/A
16.3	Witnessing and Commissioning		N/A
16.4	Operational Notification		N/A
17	Type B Compliance Testing, Commissioning and Operational Notification		N/A
18	Type C Compliance Testing, Commissioning and Operational Notification		N/A
19	Type D Compliance Testing, Commissioning and Operational Notification		N/A
20	Ongoing Obligations		N/A
21	Manufacturers' Information applicable to Power Park Modules		N/A
22	Type Testing and Annex information	Type test equipment as per form A2-3	P
A7.1.2	Type Verification Functional Testing of the Interface Protection		P
A7.1.2.1	Disconnection times		P
A7.1.2.2	Over / Under Voltage		P
A7.1.2.3	Over / Under Frequency		P
A7.1.2.4	Loss of Mains (LoM) Protection		P
A7.1.2.5	Re-connection		P
A7.1.2.6	Frequency Drift and Step Change Stability test.		P
A.7.1.3	Limited Frequency Sensitive Mode – Over (LFSM-O)		P

ER G99			
Clause	Requirement - Test	Result - Remark	Verdict
A.7.1.4	Power Quality		P
A.7.1.5	Short Circuit Current Contribution		P
A.7.1.6	Self-Monitoring - Solid State Disconnection		N/A

Appendices A:

A2-3 Compliance Verification Report –Tests for Type A Inverter Connected Power Generating Modules – test record

1. Operating Range: Five tests should be carried with the **Power Generating Module** operating at **Registered Capacity** and connected to a suitable test supply or grid simulation set. The power supplied by the primary source shall be kept stable within $\pm 5\%$ of the apparent power value set for the entire duration of each test sequence.

Frequency, voltage and **Active Power** measurements at the output terminals of the **Power Generating Module** shall be recorded every second. The tests will verify that the **Power Generating Module** can operate within the required ranges for the specified period of time.

The **Interface Protection** shall be disabled during the tests.

In case of a PV **Power Park Module** the PV primary source may be replaced by a DC source.

In case of a full converter **Power Park Module** (eg wind) the primary source and the prime mover **Inverter/rectifier** may be replaced by a DC source.

<p>Test 1</p> <p>Voltage = 85% of nominal (195.5 V), Frequency = 47 Hz, Power Factor = 1, Period of test 20 s</p>	<p>The graph for Test 1 shows three data series over a 37-second period. The left y-axis represents Voltage and Power in per-unit (p.u.), ranging from 78.00% to 98.00%. The right y-axis represents Frequency in Hz, ranging from 46.0 to 48.0. The x-axis is Time in seconds, from 1 to 37. The Voltage series (blue line) remains constant at approximately 85.00%. The Power series (orange line) remains constant at approximately 96.00%. The Frequency series (grey line) remains constant at 47.0 Hz.</p>
<p>Test 2</p> <p>Voltage = 85% of nominal (195.5 V), Frequency = 47.5 Hz, Power Factor = 1, Period of test 90 minutes</p>	<p>The graph for Test 2 shows three data series over a 5000-second period. The left y-axis represents Voltage and Power in per-unit (p.u.), ranging from 78.00% to 98.00%. The right y-axis represents Frequency in Hz, ranging from 46.0 to 48.0. The x-axis is Time in seconds, from 0 to 5000. The Voltage series (blue line) remains constant at approximately 85.00%. The Power series (orange line) remains constant at approximately 96.00%. The Frequency series (grey line) remains constant at 47.5 Hz.</p>

<p>Test 3</p> <p>Voltage = 110% of nominal (253 V), Frequency = 51.5 Hz, Power Factor = 1, Period of test 90 minutes</p>	<p>Graph for Test 3: Voltage and Power (p.u.) and Frequency (Hz) vs Time (s). The x-axis ranges from 0 to 5000 seconds. The left y-axis shows Voltage and Power (p.u.) from 96.00% to 112.00%. The right y-axis shows Frequency (Hz) from 51.0 to 52.0. Voltage (blue line) is constant at 110.00%. Power (orange line) is constant at 102.00%. Frequency (grey line) is constant at 51.5 Hz.</p>
<p>Test 4</p> <p>Voltage = 110% of nominal (253 V), Frequency = 52.0 Hz, Power Factor = 1, Period of test 15 minutes</p>	<p>Graph for Test 4: Voltage and Power (p.u.) and Frequency (Hz) vs Time (s). The x-axis ranges from 0 to 800 seconds. The left y-axis shows Voltage and Power (p.u.) from 96.00% to 112.00%. The right y-axis shows Frequency (Hz) from 51.0 to 52.4. Voltage (blue line) is constant at 110.00%. Power (orange line) is constant at 102.00%. Frequency (grey line) is constant at 52.0 Hz.</p>
<p>Test 5 RoCoF withstand</p> <p>Confirm that the Power Generating Module is capable of staying connected to the Distribution Network and operate at rates of change of frequency up to 1 Hz^s⁻¹ as measured over a period of 500 ms. Note that this is not expected to be demonstrated on site.</p>	<p>Graph for Test 5: Power (W) and Frequency (Hz) vs Time (s). The x-axis ranges from 0 to 6.5 seconds. The left y-axis shows Power (W) from 0 to 12000. The right y-axis shows Frequency (Hz) from 48.0 to 52.0. Power (blue line) is constant at 10000 W. Frequency (orange line) starts at 49.0 Hz at 0s, rises to 51.0 Hz at 3s, and then falls back to 49.0 Hz by 5.5s.</p>

2. Power Quality – Harmonics:

For Power Generating Modules of Registered Capacity of less than 75 A per phase (ie 50 kW) the test requirements are specified in Annex A.7.1.5. These tests should be carried out as specified in BS EN 61000-3-12. The results need to comply with the limits of Table 2 of BS EN 61000-3-12 for single phase equipment and Table 3 of BS EN 61000-3-12 for three phase equipment.

Power Generating Modules with emissions close to the limits laid down in BS EN 61000-3-12 may require the installation of a transformer between 2 and 4 times the rating of the Power Generating Module in order to accept the connection to a Distribution Network.

For Power Generating Modules of Registered Capacity of greater than 75 A per phase (ie 50 kW) the installation must be designed in accordance with EREC G5.

Power Generating Module tested to BS EN 61000-3-12

Power Generating Module rating per phase (rpp)			10	kVA	Harmonic % = Measured Value (A) x 23/rating per phase (kVA)	
Harmonic	At 45-55% of Registered Capacity		100% of Registered Capacity		Limit in BS EN 61000-3-12	
	Measured Value MV in Amps	%	Measured Value MV in Amps	%	1 phase	3 phase
2	0.1030	0.2368	0.0479	0.1102	8%	8%
3	0.1267	0.2915	0.4330	0.9959	21.6%	Not stated
4	0.0254	0.0585	0.0557	0.1281	4%	4%
5	0.0626	0.1441	0.2088	0.4803	10.7%	10.7%
6	0.0135	0.0310	0.0198	0.0455	2.67%	2.67%
7	0.0325	0.0746	0.0808	0.1858	7.2%	7.2%
8	0.0186	0.0428	0.0205	0.0471	2%	2%
9	0.0221	0.0509	0.1090	0.2507	3.8%	Not stated
10	0.0160	0.0369	0.0235	0.0541	1.6%	1.6%
11	0.0159	0.0365	0.0469	0.1078	3.1%	3.1%
12	0.0142	0.0326	0.0229	0.0527	1.33%	1.33%
13	0.0159	0.0366	0.0363	0.0835	2%	2%
THD ¹	0.9235%		1.2233%		23%	13%
PWHD ²	0.3774%		0.5231%		23%	22%

This test performed on model HNS10000TL

¹ THD = Total Harmonic Distortion

²PWHD = Partial Weighted Harmonic Distortion

3. Power Quality – Voltage fluctuations and Flicker:

For Power Generating Modules of Registered Capacity of less than 75 A per phase (ie 50 kW) these tests should be undertaken in accordance with Annex A.7.1.4.3. Results should be normalised to a standard source impedance, or if this results in figures above the limits set in BS EN 61000-3-11 to a suitable Maximum Impedance.

For Power Generating Modules of Registered Capacity of greater than 75 A per phase (ie 50 kW) the installation shall be designed in accordance with EREC P28.

The standard test impedance is 0.4 Ω for a single phase Power Generating Module (and for a two phase unit in a three phase system) and 0.24 Ω for a three phase Power Generating Module (and for a two phase unit in a split phase system). Please ensure that both test and standard impedance are completed on this form. If the test impedance (or the measured impedance) is different to the standard impedance, it must be normalised to the standard impedance as follows (where the Power Factor of the generation output is 0.98 or above):

d max normalised value = (Standard impedance / Measured impedance) x Measured value.

Where the Power Factor of the output is under 0.98 then the X to R ratio of the test impedance should be close to that of the standard impedance.

The stopping test should be a trip from full load operation.

The duration of these tests needs to comply with the particular requirements set out in the testing notes for the technology under test.

The test date and location must be declared.

Test start date	2022-06-20			Test end date	2022-06-27			
Test location	Intertek Testing Services Shanghai.							
	Starting			Stopping			Running	
	d max	dc	d(t)	d max	dc	d(t)	P st	P It 2 hours
Measured Values at test impedance	--	-	-	-	-	-	-	-
Normalised to standard impedance	0.53	0.19	0	0.70	0.38	0	0.19	0.17
Normalised to required maximum impedance	-	-	-	-	-	-	-	-
Limits set under BS EN 61000-3-11	4%	3.3%	3.3 %	4%	3.3 %	3.3%	1.0	0.65

Test Impedance	R	0.4		XI	0.25	
Standard Impedance	R	0.24 * 0.4 ^		XI	0.15 * 0.25 ^	
Maximum Impedance	R	--		XI	--	

* Applies to three phase and split single phase Power Generating Modules. Delete as appropriate.

^ Applies to single phase Power Generating Module and Power Generating Modules using two phases on a three phase system. Delete as appropriate.

4 Power quality – DC injection: The tests should be carried out on a single Generating Unit. Tests are to be carried out at three defined power levels $\pm 5\%$. At 230 V a 50 kW three phase Inverter has a current output of 217 A so DC limit is 543 mA. These tests should be undertaken in accordance with Annex A.7.1.4.4.
 The % DC injection (“as % of rated AC current” below) is calculated as follows:
 $\% \text{ DC injection} = \text{Recorded DC value in Amps} / \text{Base current}$
 where the base current is the **Registered Capacity** (W) / Vphase. The % DC injection should not be greater than 0.25%.

Model: ESI 6K-S1			
Test power level	10%	55%	100%
Recorded value in Amps	0.0021	0.0018	0.0013
as % of rated AC current	0.005%	0.004%	0.003%
Limit	0.25%	0.25%	0.25%

5. Power Factor: The tests should be carried out on a single Power Generating Module. Tests are to be carried out at three voltage levels and at Registered Capacity. Voltage to be maintained within $\pm 1.5\%$ of the stated level during the test. These tests should be undertaken in accordance with Annex A.7.1.4.2.
 Note that the value of voltage stated in brackets assumes a **LV** connection. This should be adjusted for **HV** as required.

Voltage	0.94 pu (216.2 V)	1 pu (230 V)	1.1 pu (253 V)
Measured value	0.9999	0.9999	0.9998
Power Factor Limit	>0.95	>0.95	>0.95

6. Protection – Frequency tests: These tests should be carried out in accordance with the Annex A.7.1.2.3. These tests should be carried out in accordance with the Annex A.7.1.2.3. For trip tests, frequency and time delay should be stated. For “no trip tests”, “no trip” can be stated.

Function	Setting		Trip test		“No trip tests”	
	Frequency	Time delay	Frequency	Time delay	Frequency /time	Confirm no trip
U/F stage 1	47.5 Hz	20 s	47.5	20.23	47.7 Hz 30 s	No trip
U/F stage 2	47 Hz	0.5 s	47.0	0.572	47.2 Hz 19.5 s	No trip
					46.8 Hz 0.45 s	No trip
O/F	52 Hz	0.5 s	52.0	0.528	51.8 Hz 120.0 s	No trip
					52.2 Hz 0.45 s	No trip

Note. For frequency trip tests the frequency required to trip is the setting ± 0.1 Hz. In order to measure the time delay a larger deviation than the minimum required to operate the projection can be used. The “No trip tests” need to be carried out at the setting ± 0.2 Hz and for the relevant times as shown in the table above to ensure that the protection will not trip in error.

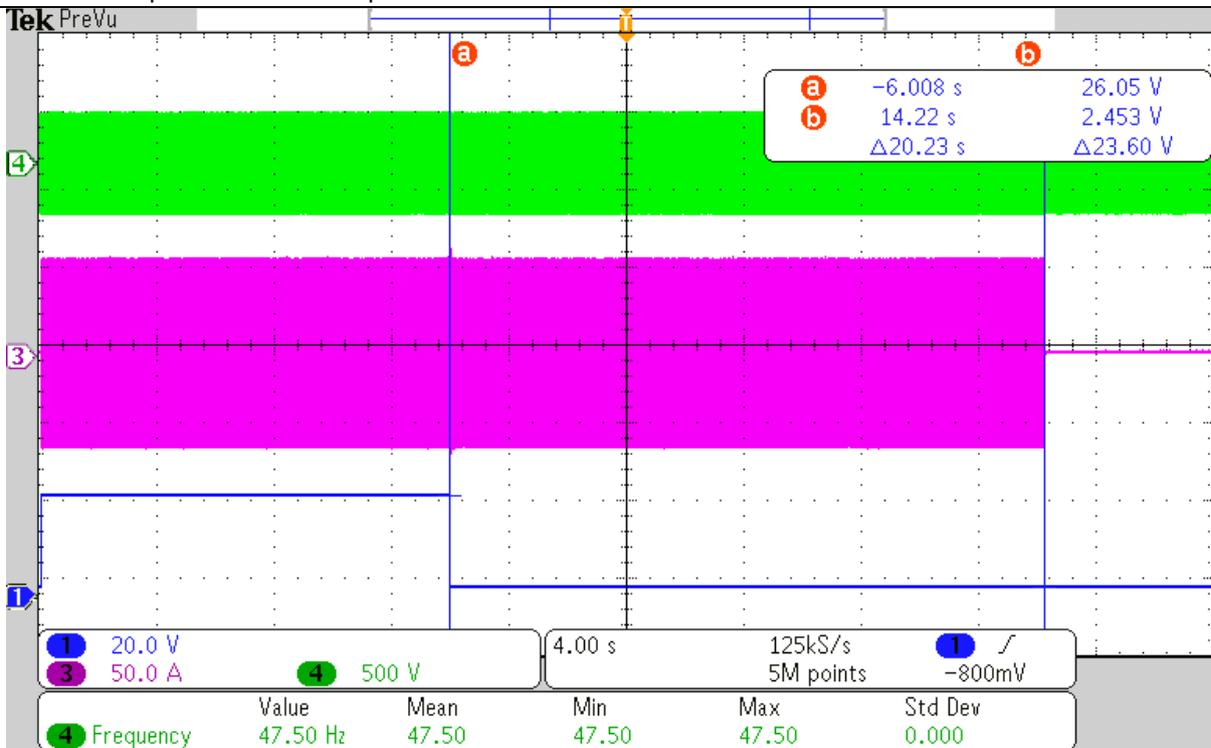

U/F stage 1

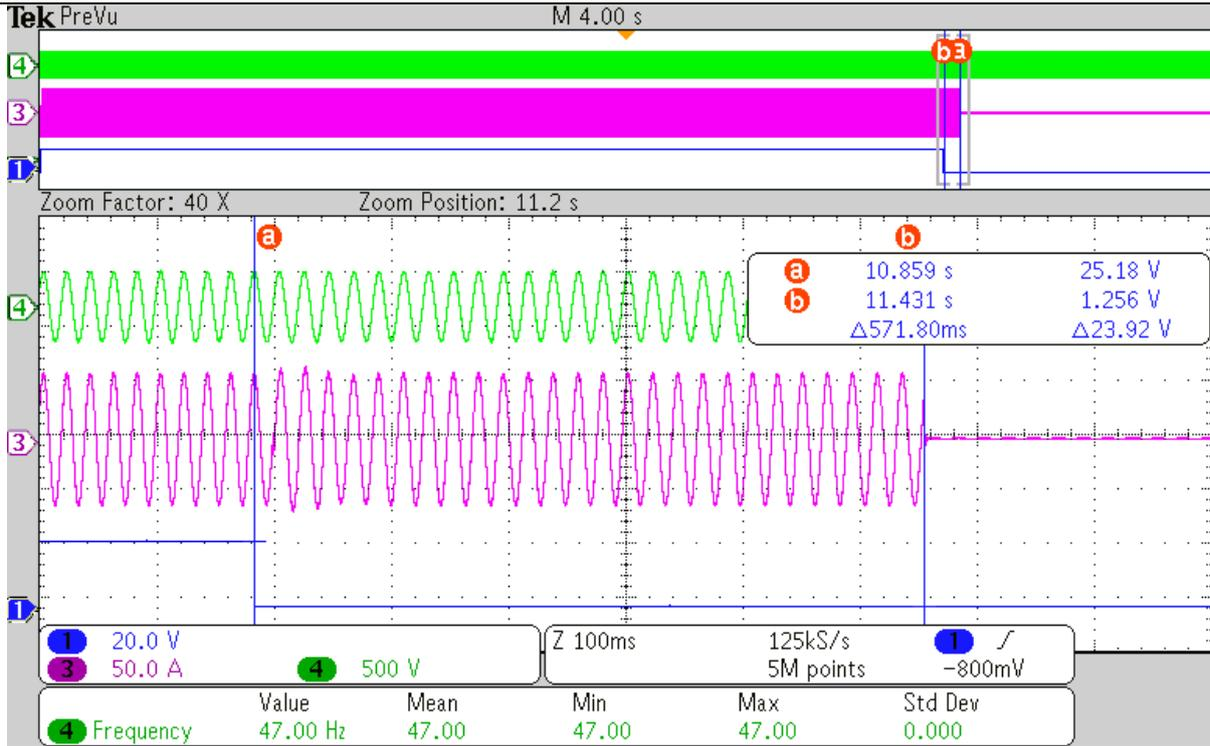

U/F stage 2

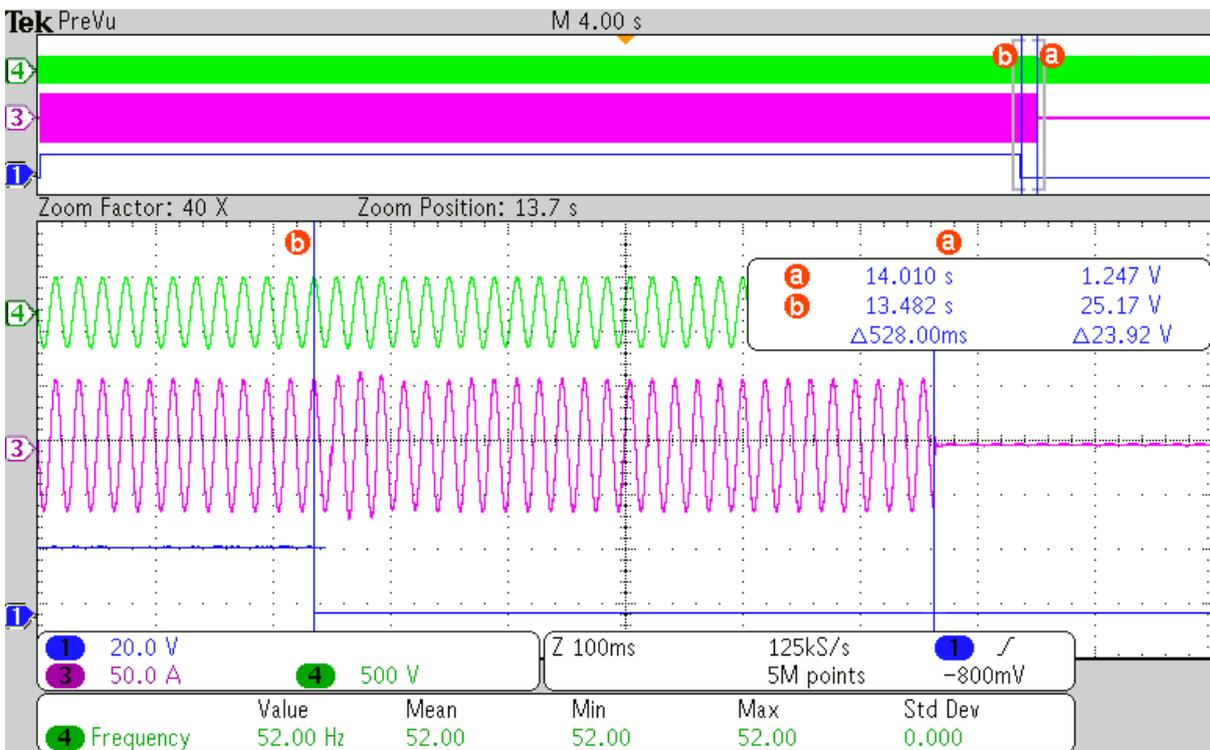

Over frequency at 52.0Hz

7. Protection – Voltage tests: These tests should be carried out in accordance with Annex A.7.1.2.2. For trip tests, voltage and time delay should be stated. For “no trip tests”, “no trip” can be stated.

Note that the value of voltage stated below assumes a LV connection This should be adjusted for HV taking account of the VT ratio as required.

Function	Setting		Trip test		“No trip tests”	
	Voltage	Time delay	Voltage	Time delay	Voltage /time	Confirm no trip
U/V	0.8 pu (184 V)	2.5 s	182.5	2.56	188 V 3.5 s	No trip
					180 V 2.45 s	No trip
O/V stage 1	1.14 pu (262.2 V)	1.0 s	264.3	1.028	258.6 V 2.0 s	No trip
O/V stage 2	1.19 pu (273.7 V)	0.5 s	274.2	0.528	269.7 V 0.95s	No trip
					277.7 V 0.45 s	No trip

Note for Voltage tests the Voltage required to trip is the setting ± 3.45 V. The time delay can be measured at a larger deviation than the minimum required to operate the protection. The No trip tests need to be carried out at the setting ± 4 V and for the relevant times as shown in the table above to ensure that the protection will not trip in error.

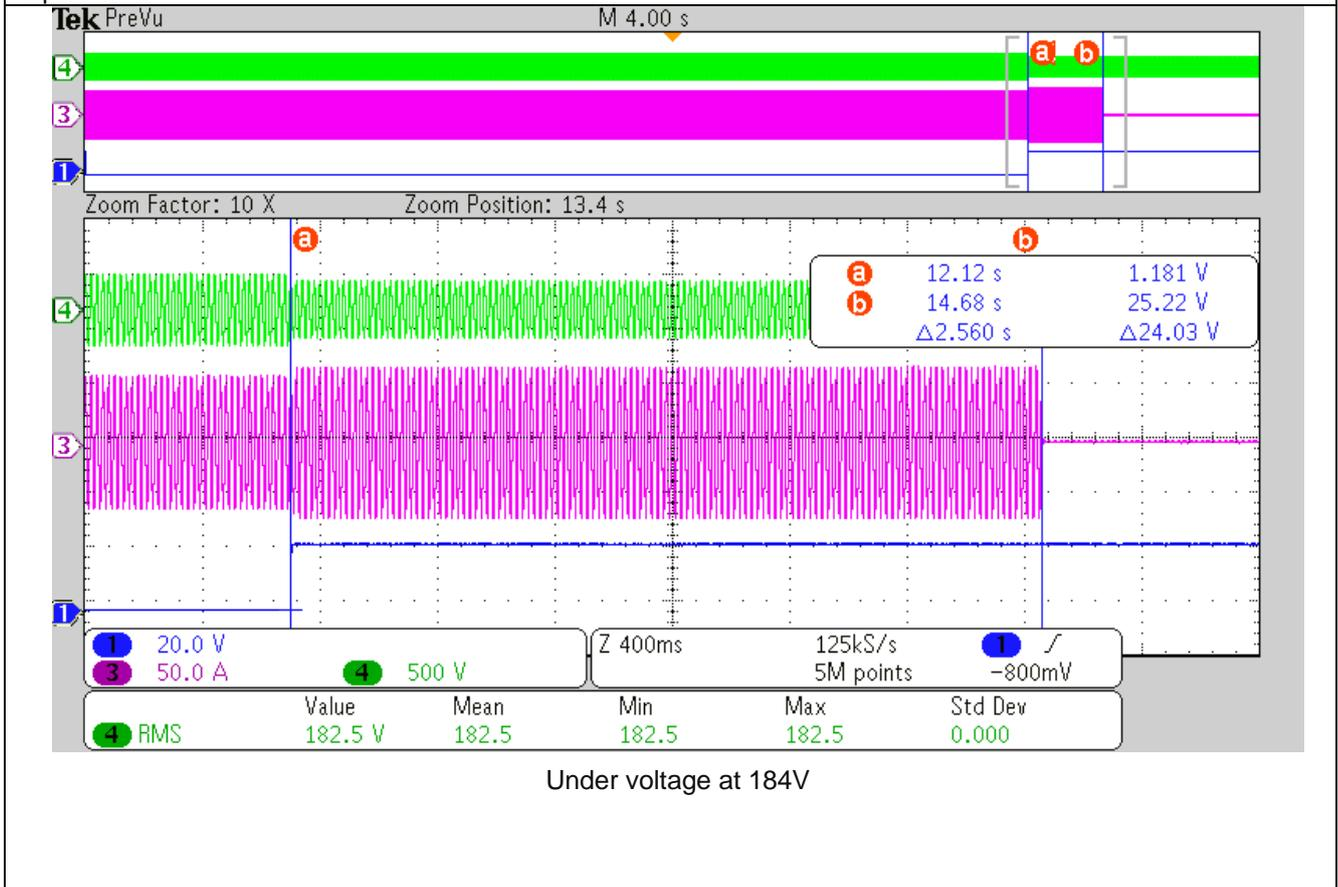

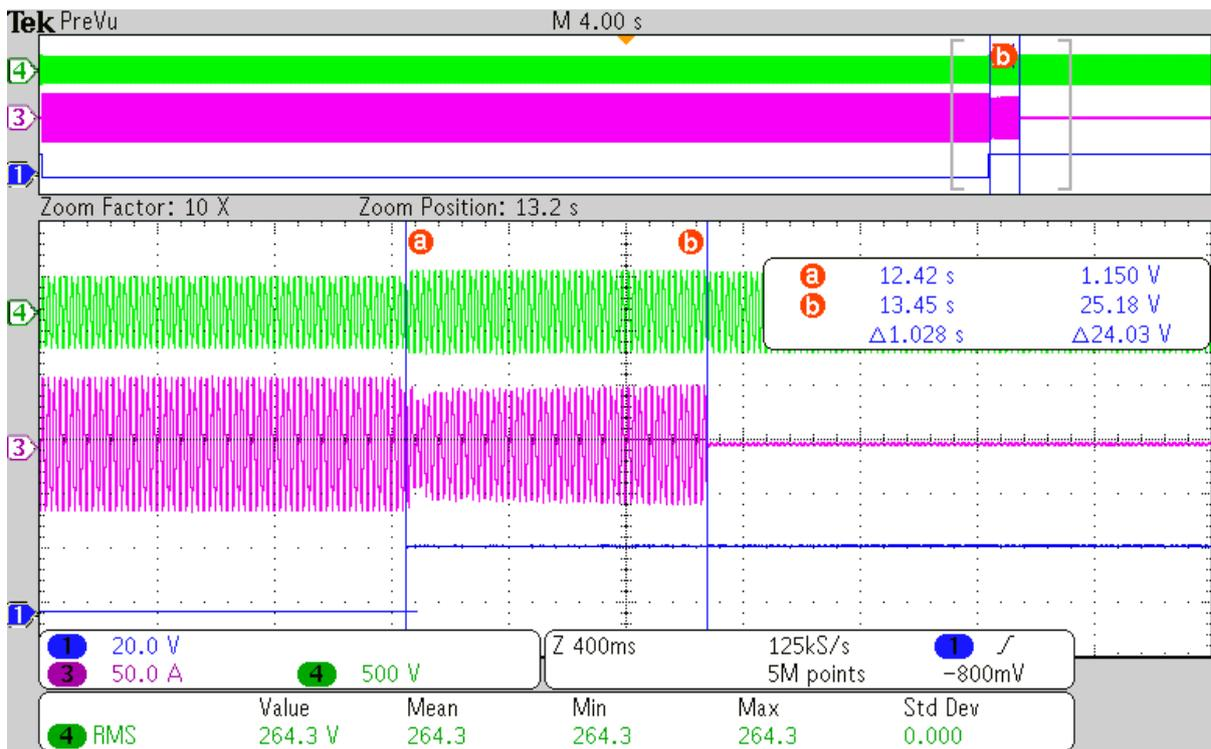

O/V stage 1

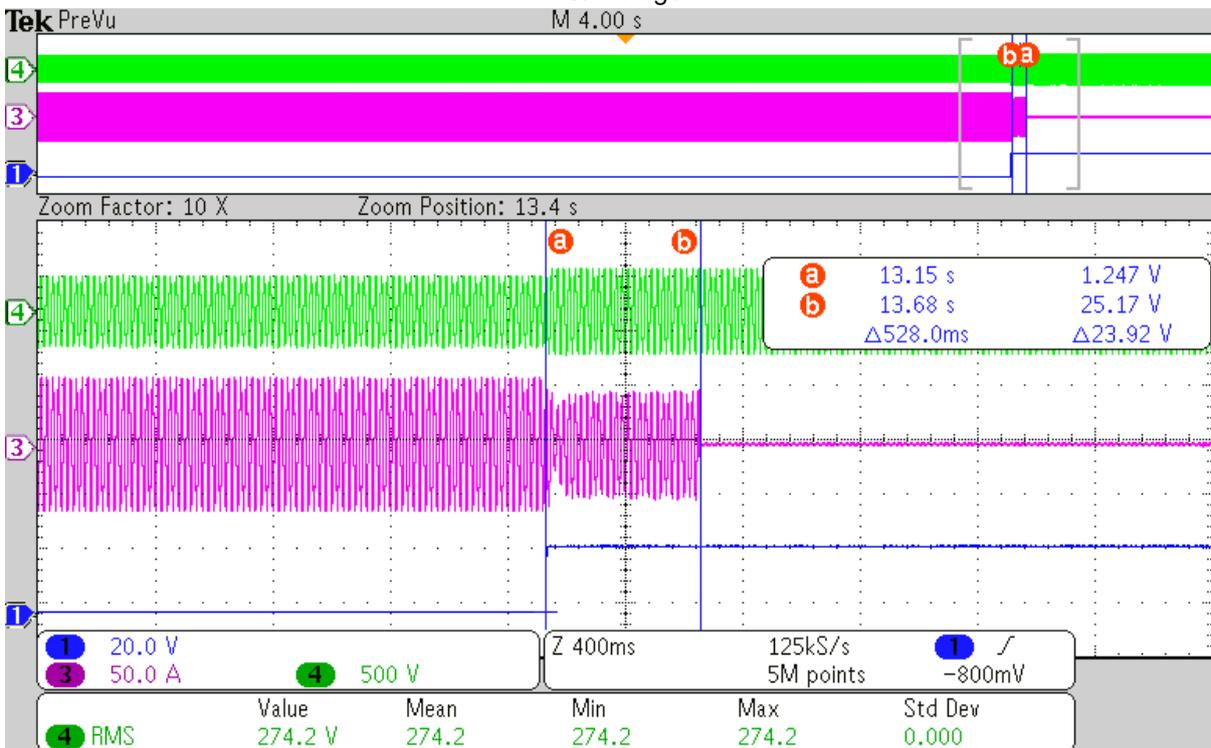

O/V stage 2

8. Protection – Loss of Mains test: These tests should be carried out in accordance with BS EN 62116. Annex A.7.1.2.4.

The following sub set of tests should be recorded in the following table.

Test Power and imbalance	33% -5% Q Test 22	66% -5% Q Test 12	100% -5% P Test 5	33% +5% Q Test 31	66% +5% Q Test 21	100% +5% P Test 10
Trip time. Limit is 0.5s	0.135s	0.137s	0.178s	0.165s	0.151s	0.153s

Loss of Mains Protection, Vector Shift Stability test. This test should be carried out in accordance with Annex A.7.1.2.6.

	Start Frequency	Change	Confirm no trip
Positive Vector Shift	49.5 Hz	+50 degrees	No trip
Negative Vector Shift	50.5 Hz	- 50 degrees	No trip

Loss of Mains Protection, RoCoF Stability test: This test should be carried out in accordance with Annex A.7.1.2.6.

Ramp range	Test frequency ramp:	Test Duration	Confirm no trip
49.0 Hz to 51.0 Hz	+0.95 Hzs ⁻¹	2.1 s	No trip
51.0 Hz to 49.0 Hz	-0.95 Hzs ⁻¹	2.1 s	No trip

<p>9. Limited Frequency Sensitive Mode – Over frequency test: The test should be carried out using the specific threshold frequency of 50.4 Hz and Droop of 10%.</p> <p>This test should be carried out in accordance with Annex A.7.1.3.</p>				
<p>Active Power response to rising frequency/time plots are attached if frequency injection tests are undertaken in accordance with Annex A.7.2.4.</p>				Y/N
<p>Alternatively, simulation results should be noted below:</p>				
Test sequence at Registered Capacity >80%	Measured Active Power Output	Frequency	Primary Power Source	Active Power Gradient Droop(%)
Step a) 50.00Hz ±0.01Hz	10049.83	50.00Hz	Photovoltaic array Simulator 10265W	-
Step b) 50.45Hz ±0.05Hz	9940.97	50.45Hz		9.23
Step c) 50.70Hz ±0.10Hz	9410.01	50.70Hz		9.42
Step d) 51.15Hz ±0.05Hz	8516.87	51.15Hz		9.83
Step e) 50.70Hz ±0.10Hz	9406.46	50.70Hz		9.37
Step f) 50.45Hz ±0.05Hz	9937.65	50.45Hz		8.96
Step g) 50.00Hz ±0.01Hz	10043.77	50.00Hz		-
Test sequence at Registered Capacity 40% - 60%	Measured Active Power Output	Frequency	Primary Power Source	Active Power Gradient Droop(%)
Step a) 50.00Hz ±0.01Hz	5004.70	50.00Hz	Photovoltaic array Simulator 5236W	-
Step b) 50.45Hz ±0.05Hz	4946.85	50.45Hz		8.65
Step c) 50.70Hz ±0.10Hz	4697.82	50.70Hz		9.78
Step d) 51.15Hz ±0.05Hz	4242.82	51.15Hz		9.85
Step e) 50.70Hz ±0.10Hz	4708.21	50.70Hz		10.13
Step f) 50.45Hz ±0.05Hz	4948.66	50.45Hz		8.93
Step g) 50.00Hz ±0.01Hz	5007.67	50.00Hz		-

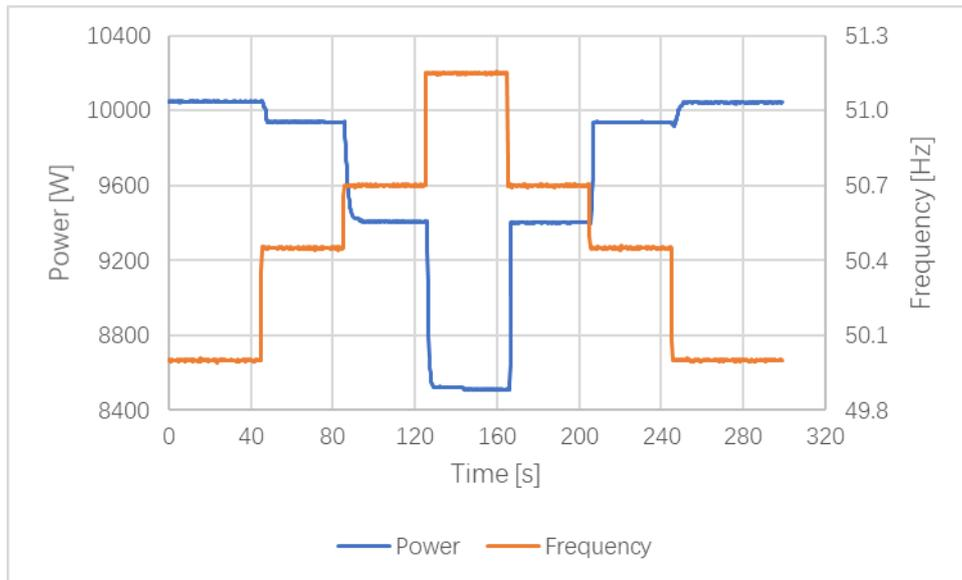

Test sequence at Registered Capacity =100%

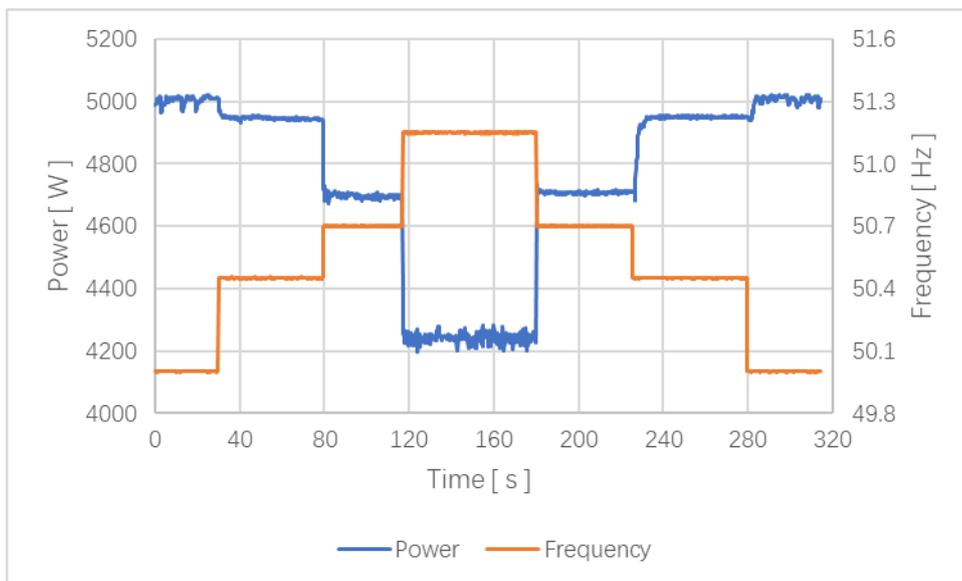

Test sequence at Registered Capacity =50%

10. Protection – Re-connection timer.					
Test should prove that the reconnection sequence starts after a minimum delay of 20 s for restoration of voltage and frequency to within the stage 1 settings of Table 10.1.					
Time delay setting	Measured delay	Checks on no reconnection when voltage or frequency is brought to just outside stage 1 limits of Table 10.1.			
40	43.9	At 1.16 pu (266.2 V)	At 0.85 pu (180.0 V)	At 47.4 Hz	At 52.1 Hz
Confirmation that the Power Generating Module does not re-connect.		Not connection	Not connection	Not connection	Not connection

11. Fault level contribution: These tests shall be carried out in accordance with EREC G99 Annex A.7.1.5.		
For Inverter output		
Time after fault	Volts	Amps
20ms	125.2V	12A
100ms	--	--
250ms	--	--
500ms	--	--
Time to trip	0.088	In seconds

12. Self-Monitoring solid state switching: No specified test requirements. Refer to Annex A.7.1.7.	
It has been verified that in the event of the solid state switching device failing to disconnect the Power Park Module, the voltage on the output side of the switching device is reduced to a value below 50 volts within 0.5 s.	N/A

13. Wiring functional tests: If required by para 15.2.1.	
Confirm that the relevant test schedule is attached (tests to be undertaken at time of commissioning)	N/A

14. Logic interface (input port).	
Confirm that an input port is provided and can be used to shut down the module.	Yes
Provide high level description of logic interface, e.g. details in 11.1.3.1 such as AC or DC signal (the additional comments box below can be used)	Yes

15. Cyber security	
Confirm that the Power Generating Module has been designed to comply with cyber security requirements, as detailed in 9.1.7.	P
Additional comments.	
The Manufacturer of the Power Generating Module has provided a statement describing how the Power Generating Module has been designed to comply with cyber security requirements in 9.1.7.	

Protection. Loss of Mains test.-BS EN 62116
List of tested condition and run on time

No.	PEUT ¹⁾ (% of EUT rating)	Reactive load (% of QL in 6.1.d)1)	PAC ²⁾ (% of nominal)	QAC ³⁾ (% of nominal)	Run on time (ms)	P _{EUT} (W)	Actual Qf	V _{DC}	Remarks ⁴⁾
1.	100	100	0	0	224	10000	1.00	378	Test A at BL
2.	66	66	0	0	171	6600	0.99	275	Test B at BL
3.	33	33	0	0	246	3300	1.00	152	Test C at BL
4.	100	100	-5	-5	118	10000	1.02	378	Test A at IB
5.	100	100	-5	0	178	10000	1.05	378	Test A at IB
6.	100	100	-5	+5	152	10000	1.08	378	Test A at IB
7.	100	100	0	-5	121	10000	0.97	378	Test A at IB
8.	100	100	0	+5	167	10000	1.02	378	Test A at IB
9.	100	100	+5	-5	175	10000	0.93	378	Test A at IB
10.	100	100	+5	0	153	10000	0.95	378	Test A at IB
11.	100	100	+5	+5	148	10000	0.97	378	Test A at IB
12.	66	66	0	-5	137	6600	0.96	275	Test B at IB
13.	66	66	0	-4	150	6600	0.97	275	Test B at IB
14.	66	66	0	-3	145	6600	0.97	275	Test B at IB
15.	66	66	0	-2	156	6600	0.98	275	Test B at IB
16.	66	66	0	-1	149	6600	0.98	275	Test B at IB
17.	66	66	0	1	159	6600	0.99	275	Test B at IB
18.	66	66	0	2	165	6600	1.00	275	Test B at IB
19.	66	66	0	3	161	6600	1.00	275	Test B at IB
20.	66	66	0	4	163	6600	1.01	275	Test B at IB
21.	66	66	0	5	151	6600	1.01	275	Test C at IB
22.	33	33	0	-5	135	3300	0.97	152	Test C at IB
23.	33	33	0	-4	141	3300	0.98	152	Test C at IB
24.	33	33	0	-3	152	3300	0.98	152	Test C at IB
25.	33	33	0	-2	141	3300	0.99	152	Test C at IB
26.	33	33	0	-1	169	3300	0.99	152	Test C at IB
27.	33	33	0	1	191	3300	1.00	152	Test C at IB
28.	33	33	0	2	172	3300	1.01	152	Test C at IB
29.	33	33	0	3	173	3300	1.01	152	Test C at IB
30.	33	33	0	4	168	3300	1.02	152	Test C at IB
31.	33	33	0	5	165	3300	1.02	152	Test C at IB

Remark:
1) PEUT: EUT output power
2) PAC: Real power flow at S1 in Figure 1. Positive means power from EUT to utility. Nominal is the 0 % test condition value.
3) QAC: Reactive power flow at S1 in Figure 1. Positive means power from EUT to utility. Nominal is the 0 % test condition value.
4) BL: Balance condition, IB: Imbalance condition.

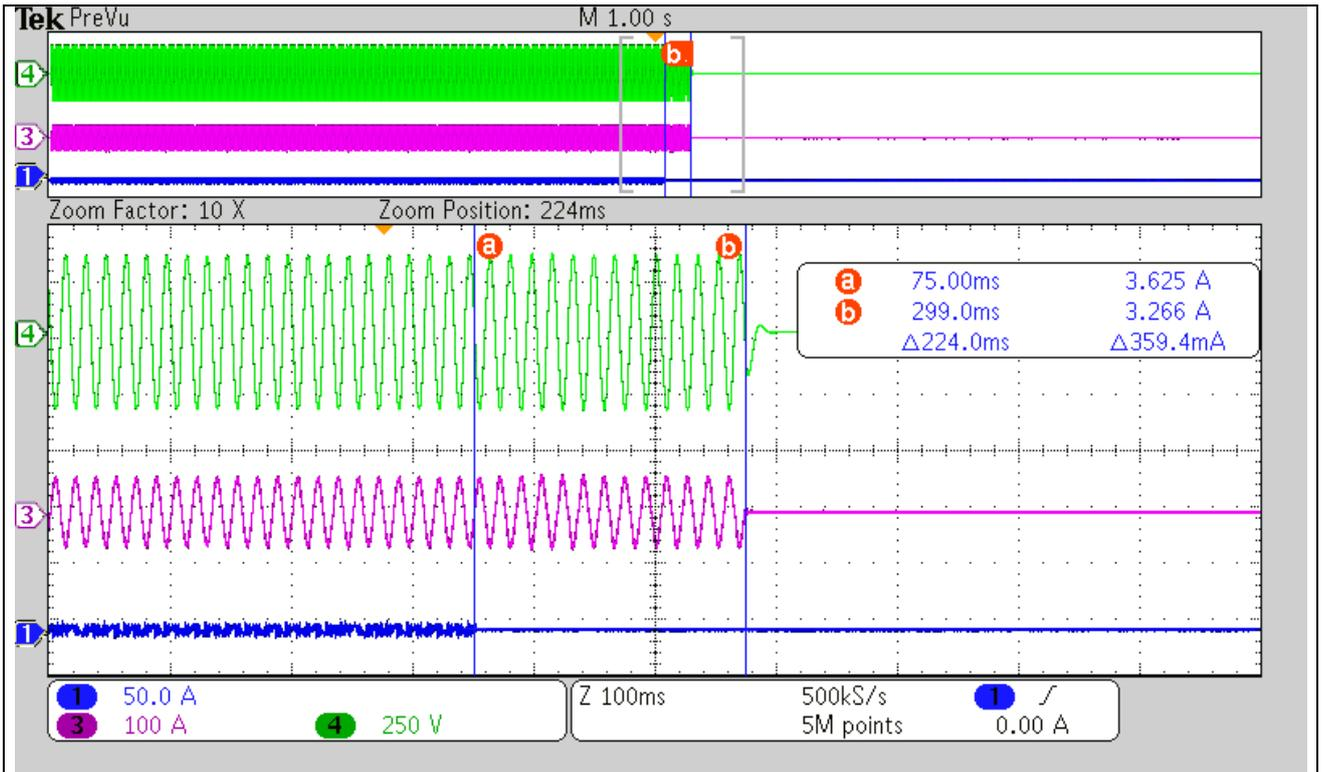

P_{EUT} 100%, P_{AC} 0%, Q_{AC} 0%, = 224ms

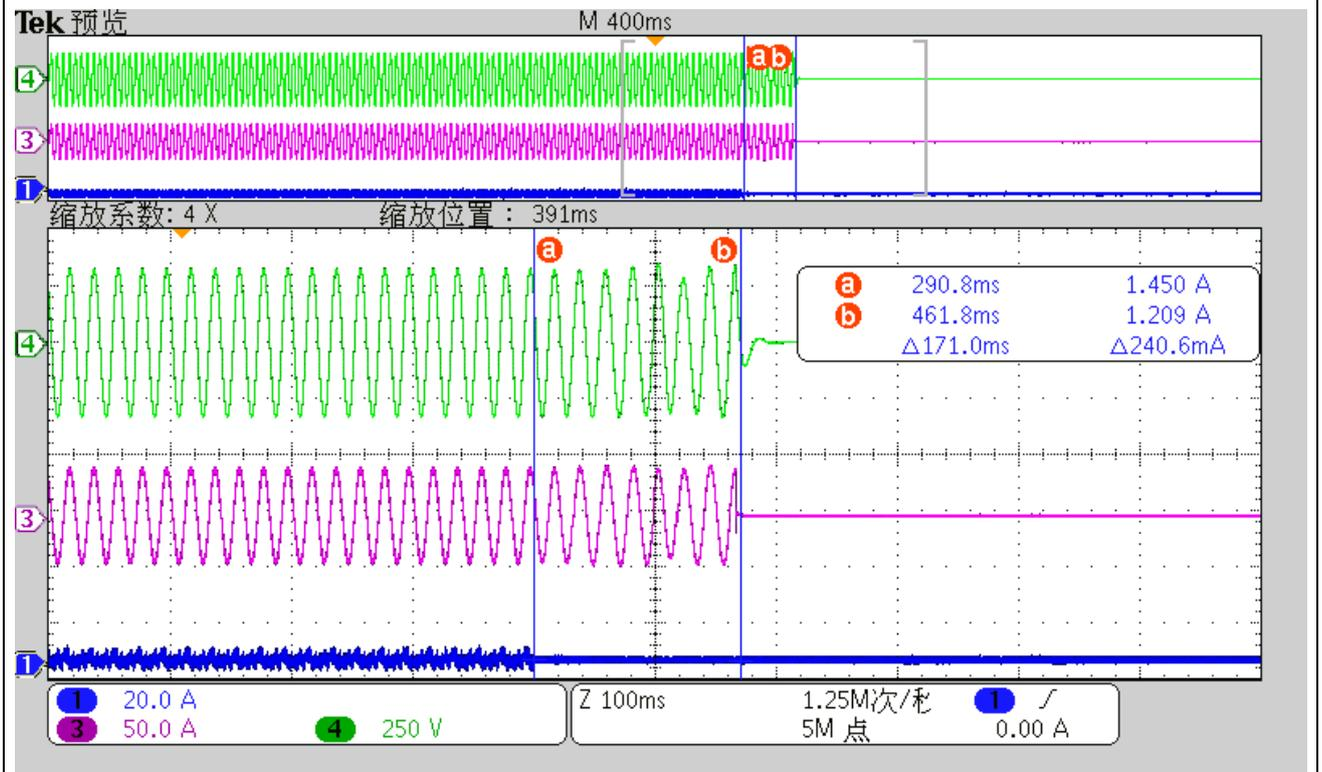

P_{EUT} 66%, P_{AC} 0%, Q_{AC} 0%, = 171ms

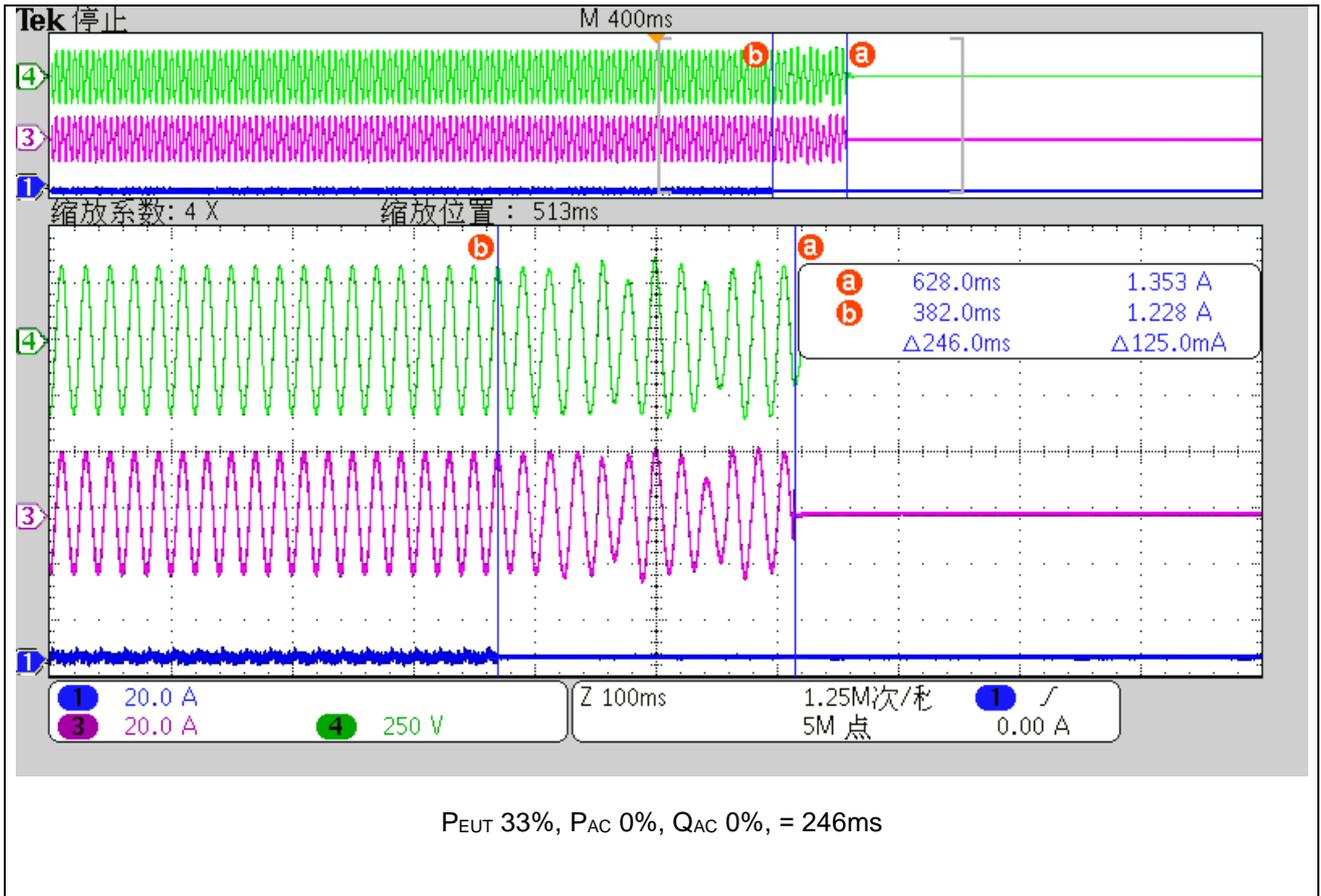

Appendices B Photos:



Overview - HNS5000TL



Overview - HNS5000TL



Overview - HNS5000TL



Overview - HNS5000TL



Overview - HNS5000TL



Overview - HNS5000TL

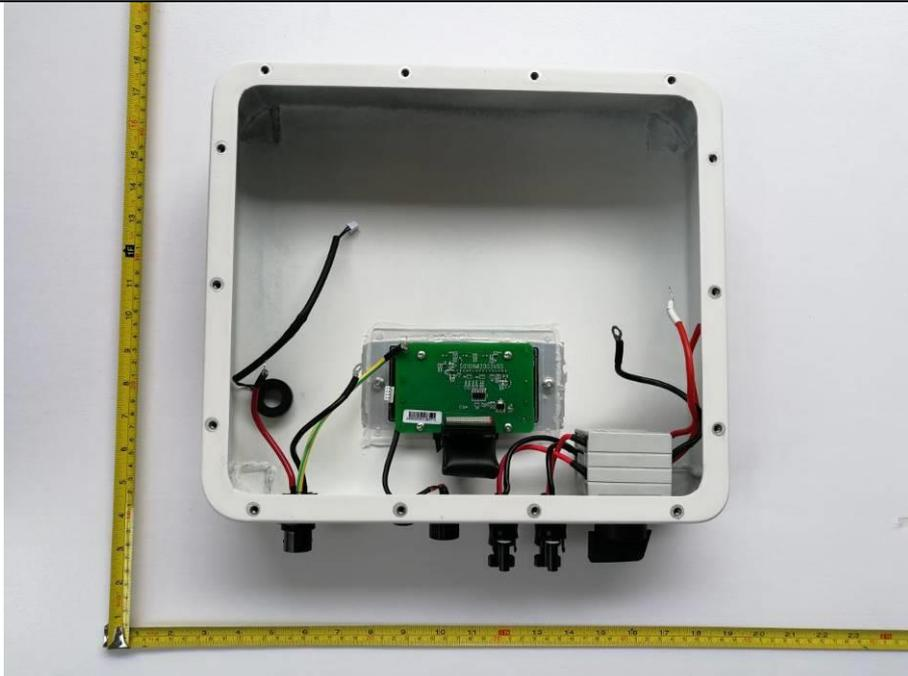

Overview - HNS8000TL



Overview - HNS8000TL



Overview - HNS8000TL

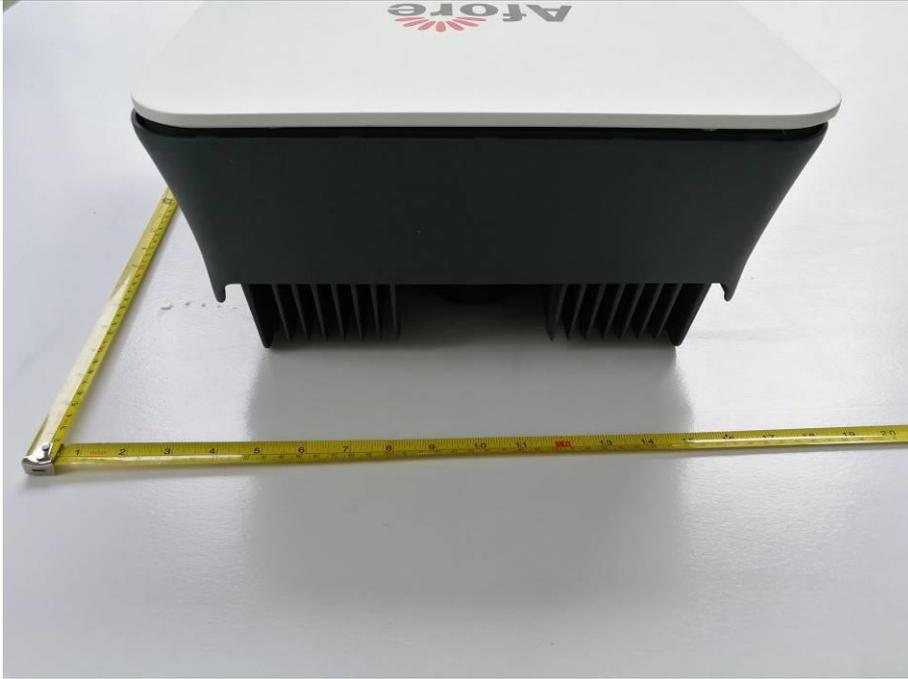

Overview - HNS8000TL



Overview - HNS8000TL-Secondary grounding



Internal View-grounding



Overview - HNS8000TL



Overview - HNS10000TL



Overview - HNS10000TL



Overview - HNS10000TL



Overview - HNS1000TL



Overview - HNS1000TL



Overview - HNS10000TL



Overview - HNS10000TL



Overview - HNS10000TL



Overview - HNS10000TL

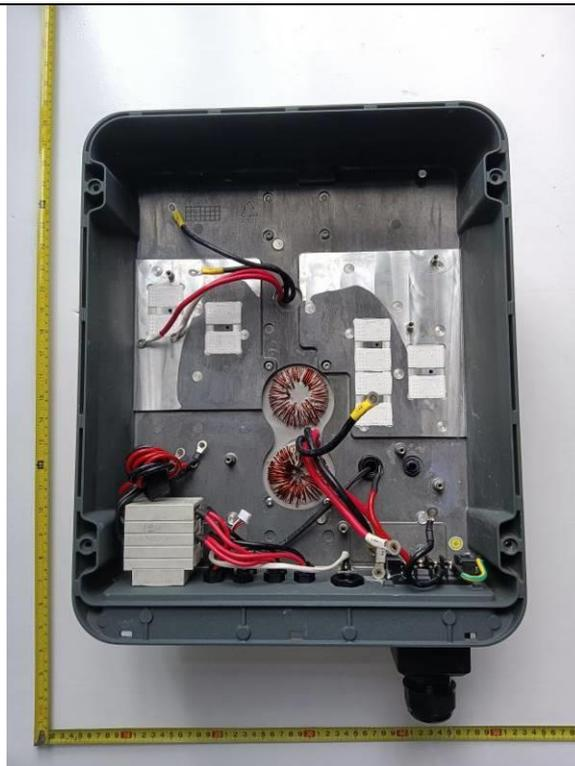

End